



MICHELIN

2026

ITALY

Agnelli
SINCE 1907

**MICHELIN GUIDE
CEREMONY PARTNER**



**HORECA
PROFESSIONAL**

ORO E ARGENTO
GOLD AND SILVER

12

MULTI-PLY
5PLY - 3PLY - 2PLY

20

ACCIAIO INOX
STAINLESS STEEL

46

FERRO
IRON

58

RAME
COPPER

60

ALLUMINIO PROFESSIONALE
PROFESSIONAL ALUMINIUM

86

ALLUMINIO PROFESSIONALE ANTIADERENTE
PROFESSIONAL NON-STICK ALUMINUM

118

SERVIZIO IN TAVOLA <i>FROM THE KITCHEN TO THE TABLE</i>	152
--	-----

GHISA E PIETRA <i>CAST IRON AND STONE</i>	174
--	-----

TEGLIE E BACINELLE GN <i>GN TRAYS AND PANS</i>	184
---	-----

PASTICCERIA E PIZZA <i>PASTRY AND PIZZA</i>	200
--	-----

ESPOSITORI <i>STANDS</i>	214
-----------------------------	-----

BARBECUE BBPRO <i>BBPRO BARBECUE</i>	216
---	-----

COLTELLI <i>KNIVES</i>	228
---------------------------	-----

FAMILY COOKING <i>FAMILY COOKING</i>	230
---	-----

Fondata a Bergamo nel 1907, Pentole Agnelli nasce come azienda specializzata nella lavorazione dell'alluminio. Il fondatore, Baldassare Agnelli, avvia la produzione di pentole e strumenti di cottura destinati al mondo professionale, un settore in rapida crescita nel panorama italiano dell'epoca.

Fin dall'inizio l'azienda si distingue per l'attenzione alle proprietà tecniche dei materiali e alla qualità della lavorazione. Con il passare degli anni, la produzione evolve insieme alla ristorazione italiana, rispondendo alla crescente domanda di strumenti affidabili per la cucina professionale.

Con il passaggio generazionale, la famiglia Agnelli mantiene la guida dell'azienda, consolidando il legame con la tradizione manifatturiera e ampliando la ricerca su materiali, tecnologie e controllo qualità. Oggi Pentole Agnelli è un marchio riconosciuto nel settore degli strumenti di cottura professionali, presente nelle cucine di ristoranti, laboratori e scuole di cucina.



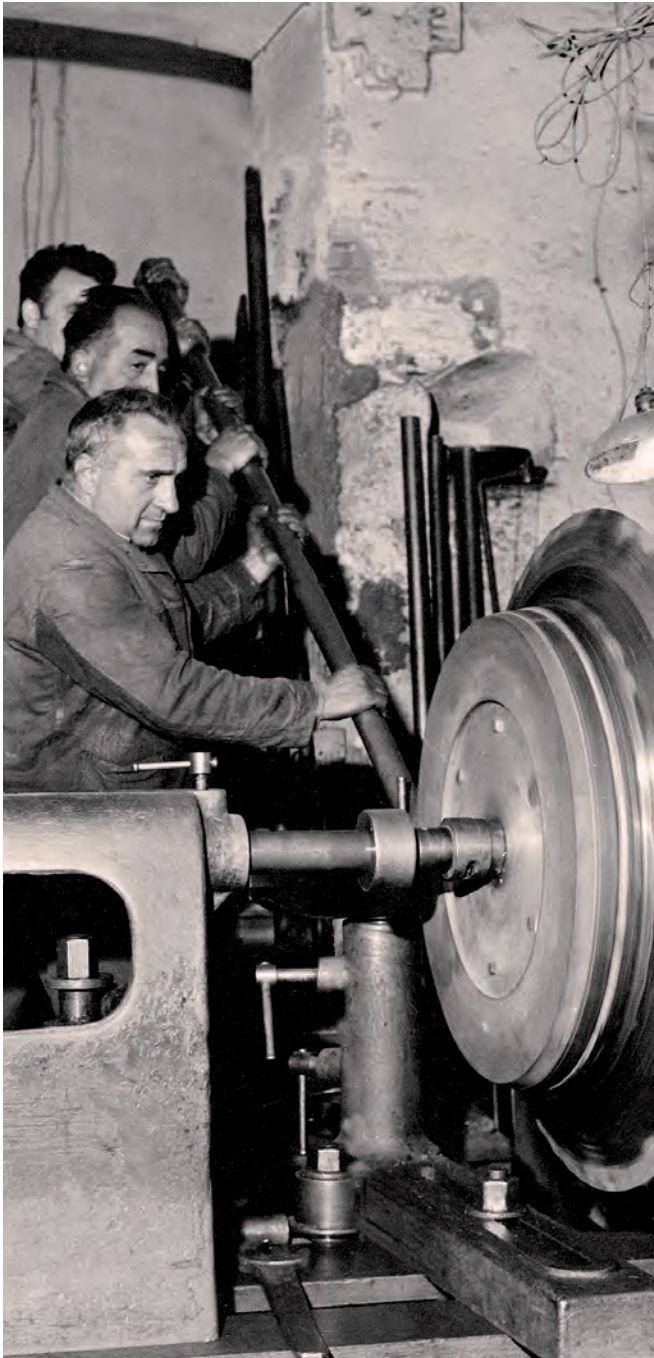

Founded in Bergamo in 1907, Pentole Agnelli began as a company specialized in aluminum processing. Its founder, Baldassare Agnelli, started producing cookware designed for professional kitchens—an industry that was rapidly growing in Italy at the time.

From the outset, the company stood out for its focus on the technical properties of materials, manufacturing quality, and product durability. Over the decades, its production evolved alongside Italian gastronomy, meeting the increasing demand for reliable tools for professional kitchens.

Now in its fourth generation, the Agnelli family continues to lead the company, preserving the manufacturing tradition while investing in research on materials, technologies, and quality control. Today, Pentole Agnelli is an established brand in the professional cookware sector, trusted by restaurants, laboratories, and culinary schools.





Ogni materiale influenza le prestazioni in cucina. La scelta del metallo giusto non è solo una questione estetica: determina la conduzione del calore, il peso dello strumento e le modalità di utilizzo.

Il grafico mette a confronto conducibilità termica e peso specifico dei principali metalli e compositi impiegati nelle nostre pentole. Scegliere bene significa cucinare meglio.

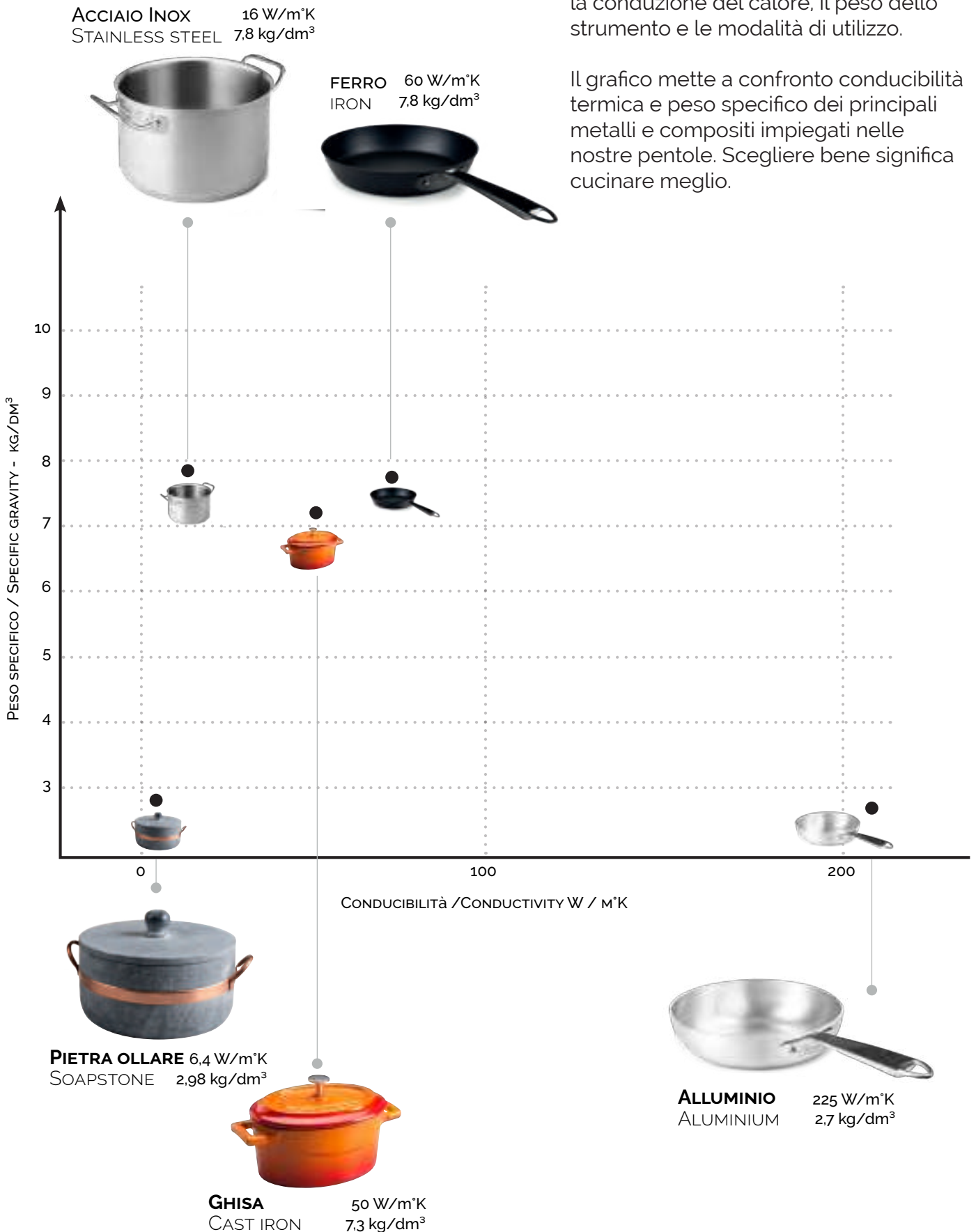

ORO 295 W/m²K
GOLD 16,7 kg/dm³



ARGENTO 420 W/m²K
SILVER 10,5 kg/dm³



300

400

CONDUCIBILITÀ / CONDUCTIVITY W / M²K



Each material affects cooking performance. The choice of the right metal is not merely an aesthetic decision: it determines heat conduction, weight, and usability.

The chart compares the thermal conductivity and density of the main metals and composites used in our cookware. Choosing the right one means cooking better



RAME 392 W/m²K
COPPER 8,9 kg/dm³

LE FORME DEGLI
STRUMENTI DI
COTTURA NE
DEFINISCONO LA
FUNZIONALITÀ.

LE FORME DEGLI STRUMENTI DI COTTURA DEFINISCONO LA LORO FUNZIONALITÀ. OGNI DETTAGLIO STRUTTURALE RISPONDE A UN'ESIGENZA PRECISA IN CUCINA, OTTIMIZZANDO TEMPI, TECNICHE E RISULTATI. A SECONDA DELLA FORMA E DEI MATERIALI IMPIEGATI CAMBIANO DESTINAZIONE D'USO E MODALITÀ DI MANUTENZIONE.

THE SHAPE OF
COOKWARE DEFINES
ITS SPECIFIC FUNCTION.

THE SHAPE OF COOKWARE DEFINES ITS FUNCTION. EVERY STRUCTURAL DETAIL SERVES A SPECIFIC PURPOSE IN THE KITCHEN, OPTIMIZING TIME, TECHNIQUES, AND RESULTS. DEPENDING ON THE SHAPE AND THE MATERIALS USED, BOTH THE INTENDED USE AND THE MAINTENANCE REQUIREMENTS CAN VARY SIGNIFICANTLY.



PENTOLA
MANICO O 2 MANIGLIE
AFFOGARE - BOLLIRE -
SBIANCCHIRE
MARINARE - SALAMOIE
STOCKPOT
POACH - BOIL - BLANCH
MARINATE - BRINES



CASSERUOLA ALTA
MANICO O 2 MANIGLIE
BRASARE - FORNO
ARROSTI - GRATIN
STUFATA
SAUCEPAN/SAUCE POT
BRAISING - BAKING
- ROASTING GRATIN
STEWING



CASSERUOLA OVALE
BRASARE - CUOCERE
AL FORNO ARROSTIRE
- GRATINARE -
STUFARE
OVAL SAUCEPOT
BRAISING - BAKING -
ROASTING - GRATIN -
STEWING



CASSERUOLA BASSA
MANICO O 2 MANIGLIE
BRASARE - CUOCERE
AL FORNO - ARROSTIRE
GRATINARE - STUFARE
MANTECARE
CASSEROLE POT/PAN
BRAISING - BAKING -
ROASTING GRATIN STEWING



TEGAME
BRASARE - STUFARE
ARROSTIRE
OMELETTE PAN
BRAISING - STEWING
ROASTING



RONDEAU
BRASARE - STUFARE
ARROSTIRE
RONDEAU
BRAISING - STEWING -
ROASTING



● PADELLA DRITTA
CAMELLARE
FRIGGERE
ARROSTIRE
FRYPAN
CAMELIZE
FRY
ROAST



● PADELLA SVASATA
ALTA "SALTAPASTA"
CUOCERE AL SALTO
MANTECARE
SAUTÉ PAN "PASTA"
SAUTÉING - MANTECARE



● PADELLA SVASATA
BASSA
CAMELLARE
FRIGGERE
ARROSTIRE
CUOCERE AL SALTO
LOW SAUTÉ PAN
CAMELIZE
FRY
ROAST
SAUTÉING



● WOK
FRIGGERE
FRY



● PADELLA MANTECARE
CUOCERE AL SALTO
MANTECARE
RISOTTARE
SAUTING - MANTECARE
RISOTTARE



PESCIERA
BOLLIRE - STUFARE -
CUOCERE AL FORNO E
AL VAPORE
FISH KETTLE
BOIL - BRAISE - BAKE
STEAM



ROSTIERA
BRASARE - STUFARE -
ARROSTIRE CUOCERE AL
FORNO E AL VAPORE
ROASTER
BRAISE - STEW - ROAST
BAKE - STEAM



TORTIERA
CUOCERE AL FORNO
GRATINARE
CAKE PAN
BAKING - GRATIN



BACINELLE FORMATI: GN 2/1
GN 1/1 - GN 2/3
CUOCERE - ARROSTIRE
RIGENERARE - CUOCERE AL
VAPORE - CONSERVARE
PANS - SIZES: GN 2/1 - GN
1/1 - GN 2/3
BAKE - ROAST - REGENERATE
STEAM- STORE



BACINELLE FORMATI: GN 2/4
GN 1/2 - GN 1/3
CUOCERE - CONSERVARE
SERVIRE - CUOCERE AL
VAPORE
PANS - SIZES: GN 2/4 - GN
1/2 - GN 1/3
BAKE - STORE - SERVE STEAM



BACINELLE FORMATI: GN 1/4
GN 1/6 - GN 1/9
PORZIONARE - GUARNIRE -
CONSERVARE - CUOCERE AL
VAPORE
PANS - SIZES: GN 1/4 GN 1/6
- GN 1/9
PORTIONING - GARNISHING -
STORING - STEAMING





per tutti i piani di cottura
for all hobs

W/K 
295
Capacità di
condurre il calore
Heat conductivity

P_s 16.7 kg/dm³
Peso specifico
Specific weight

Fondo in acciaio
ferritico per induzione
Ferritic steel bottom for induction

Manicatura in acciaio inox
Stainless steel handle



CASSERUOLA ALTA CON DUE MANIGLIE

SAUCEPOT, 2 HANDLES

Code	Ø cm	IVA esc.
ALAU104IE16IND	16	a preventivo
ALAU104IE20IND	20	a preventivo
ALAU104IE24IND	24	a preventivo



CASSERUOLA BASSA CON DUE MANIGLIE

CASSEROLE POT, 2 HANDLES

Code	Ø cm	IVA esc.
ALAU106IE20IND	20	a preventivo
ALAU106IE24IND	24	a preventivo
ALAU106IE28IND	28	a preventivo



CASSERUOLA ALTA CON CON UN MANICO

SAUCEPAN, ONE HANDLE

Code	Ø cm	IVA esc.
ALAU105IE16IND	16	a preventivo
ALAU105IE18IND	18	a preventivo
ALAU105IE20IND	20	a preventivo
ALAU105IE24IND	24	a preventivo



CASSERUOLA BASSA CON UN MANICO

CASSEROLE PAN, ONE HANDLE

Code	Ø cm	IVA esc.
ALAU107IE20IND	20	a preventivo
ALAU107IE24IND	24	a preventivo
ALAU107IE28IND	28	a preventivo



PADELLA DRITTA CON UN MANICO

FRYPAN, 1 HANDLE

Code	Ø cm	IVA esc.
ALAU111E20IND	20	a preventivo
ALAU111E24IND	24	a preventivo
ALAU111E28IND	28	a preventivo
ALAU111E32IND	32	a preventivo



PADELLA LIONESE CON UN MANICO

SAUTÉ PAN, 1 HANDLE

Code	Ø cm	IVA esc.
ALAU111/BISIE24IND	24	a preventivo
ALAU111/BISIE28IND	28	a preventivo
ALAU111/BISIE32IND	32	a preventivo



TEGAME

OMELETTE PAN, 2 HANDLES

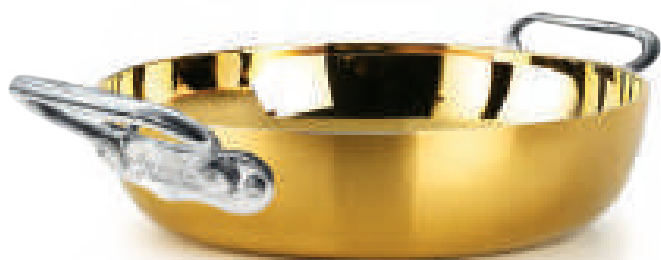

Code	Ø cm	IVA esc.
ALAU110E20IND	20	a preventivo
ALAU110E24IND	24	a preventivo
ALAU110E28IND	28	a preventivo
ALAU110E32IND	32	a preventivo



TEGAMINO

MINI OMELETTE PAN

Code	Ø cm	IVA esc.
ALAU110IES15	15	a preventivo



POLSONETTO

POLSONETTO

Code	Ø cm	IVA esc.
ALAU294IE18	18	a preventivo





W/K 
420
Capacità di
condurre il calore
Heat conductivity

P_s 10,5 kg/dm³
Peso specifico
Specific weight

Fondo in acciaio
ferritico per induzione
Ferritic steel bottom for induction

Manicatura in acciaio inox
Stainless steel handle



CASSERUOLA ALTA CON DUE MANIGLIE

SAUCEPOT, 2 HANDLES

Code	Ø cm	IVA esc.
ALAR104IE20IND	20	a preventivo
ALAR104IE24IND	24	a preventivo



CASSERUOLA BASSA CON DUE MANIGLIE

CASSEROLE POT, 2 HANDLES

Code	Ø cm	IVA esc.
ALAR106IE20IND	20	a preventivo
ALAR106IE24IND	24	a preventivo
ALAR106IE28IND	28	a preventivo



CASSERUOLA ALTA CON CON UN MANICO

SAUCEPAN, ONE HANDLE

Code	Ø cm	IVA esc.
ALAR105IE20IND	20	a preventivo
ALAR105IE24IND	24	a preventivo



CASSERUOLA BASSA CON UN MANICO

CASSEROLE PAN, ONE HANDLE

Code	Ø cm	IVA esc.
ALAR107IE20IND	20	a preventivo
ALAR107IE24IND	24	a preventivo
ALAR107IE28IND	28	a preventivo

ARGENTO
SILVER

AGNELLI SINCE 1907



TEGAME

OMELETTE PAN, 2 HANDLES

Code	Ø cm	IVA esc.
ALAU110IE20IND	20	a preventivo
ALAU110IE24IND	24	a preventivo
ALAU110IE28IND	28	a preventivo
ALAU110IE32IND	32	a preventivo



PADELLA DRITTA CON UN MANICO

FRYPAN, 1 HANDLE

Code	Ø cm	IVA esc.
ALAR111IE20IND	20	a preventivo
ALAR111IE24IND	24	a preventivo
ALAR111IE28IND	28	a preventivo



PADELLA LIONESE CON UN MANICO

SAUTÉ PAN, 1 HANDLE

Code	Ø cm	IVA esc.
ALAR111/BISIE24IND	24	a preventivo
ALAR111/BISIE28IND	28	a preventivo
ALAR111/BISIE32IND	32	a preventivo

Agnelli
SINCE 1907

ALU-INOX
5-PLY

FINITURA
LUCIDA
MIRROR FINISH



per tutti i piani di cottura
for all hobs



CASSERUOLA ALTA
CON DUE MANIGLIE INOX

SAUCEPOT WITH
TWO STAINLESS STEEL HANDLES

Code	Ø cm	H cm	lt	IVA esc.
ALUM110420	20	10,4	3,1	134,67 €
ALUM110424	24	13,4	7,2	170,05 €



CASSERUOLA BASSA
CON DUE MANIGLIE INOX

CASSEROLE POT WITH
TWO STAINLESS STEEL HANDLES

Code	Ø cm	H cm	lt	IVA esc.
ALUM110624	24	10,5	4,5	144,64 €
ALUM110628	28	11,8	7	170,45 €



ACCIAIO INOX 18/10

18/10 STAINLESS STEEL

PER UNA FACILE PULIZIA

FOR EASY CLEANING

ALLUMINIO 1050

ALUMINIUM ALLOY 1050

PER UNA PERFETTA TRASMISSIONE DEL CALORE

FOR PERFECT HEAT DISTRIBUTION

ALLUMINIO LEGA 3003

ALUMINIUM ALLOY 3003

PER UNA MAGGIORE RESISTENZA

FOR INCREASED DURABILITY

ALLUMINIO 1050

ALUMINIUM ALLOY 1050

PER UNA PERFETTA TRASMISSIONE DEL CALORE

FOR PERFECT HEAT DISTRIBUTION

ACCIAIO FERRITICO

FERRITIC STEEL

PER L'INDUZIONE

FOR INDUCTION COOKING



191
W/m²K
Capacità di condurre il calore
Heat conductivity



Durata
Durability

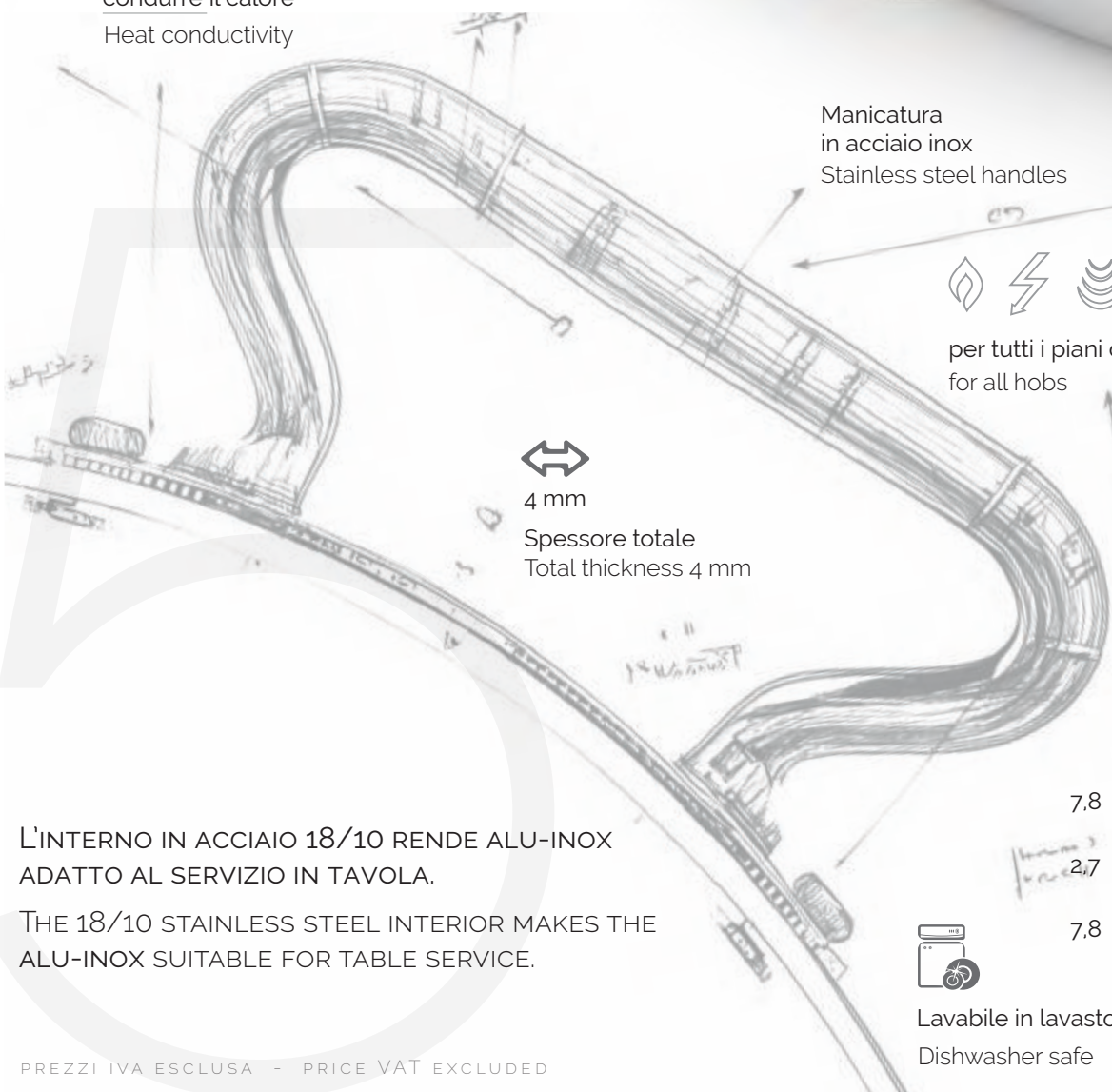

Manicatura in acciaio inox
Stainless steel handles



per tutti i piani di cottura
for all hobs



4 mm
Spessore totale
Total thickness 4 mm

P_s

Peso specifico
Specific weight

- 7.8 Acciaio inox 18/10
18/10 stainless steel
- 2.7 Alluminio 1050
Aluminium 1050
- 7.8 Acciaio ferritico
Ferritic steel

L'INTERNO IN ACCIAIO 18/10 RENDE ALU-INOX ADATTO AL SERVIZIO IN TAVOLA.

THE 18/10 STAINLESS STEEL INTERIOR MAKES THE ALU-INOX SUITABLE FOR TABLE SERVICE.



Lavabile in lavastoviglie
Dishwasher safe

ALU-INOX
5-PLY

AGNELLI SINCE 1907



CASSERUOLA BASSA
CON UN MANICO INOX

CASSEROLE PAN
WITH A STAINLESS STEEL HANDLE



Code	Ø cm	H cm	lt	IVA esc.
ALUM110720	20	8,4	2,6	110,24 €



CASSERUOLA ALTA
CON UN MANICO INOX

SAUCEPOT
WITH A STAINLESS STEEL HANDLE



Code	Ø cm	H cm	lt	IVA esc.
ALUM110516	16	10,5	2	88,98 €



CASSERUOLA ALTA
CON UN MANICO E DUE BECCUCCI

SAUCEPOT WITH A STAINLESS STEEL
HANDLE AND TWO SPOUTS



Code	Ø cm	H cm	lt	IVA esc.
ALUM110512	12	7,4	0,8	65,02 €
ALUM110514	14	8,4	1,2	73,77 €



**RONDEAU CON DUE
MANIGLIE INOX**

RONDEAU WITH TWO
STAINLESS STEEL HANDLES

Code	Ø cm	H cm	IVA esc.
ALUM111228	28	7.9	160,60 €



**PADELLA
CON UN MANICO**

FRYING PAN
WITH ONE HANDLE



Code	Ø cm	H cm	IVA esc.
ALUM111120	20	4.5	79,82 €
ALUM111124	24	5.1	97,64 €
ALUM111128	28	5.4	113,74 €
ALUM111132	32	5.9	137,77 €



**COPERCHIO IN ACCIAIO LUCIDO
CON POMOLO**

POLISHED STEEL LID WITH KNOB

Code	Ø cm	IVA esc.
ALUM12916	16	35,69 €
ALUM12920	20	38,53 €
ALUM12924	24	42,48 €
ALUM12928	28	45,87 €
ALUM12932	32	52,96 €

Agnelli
SINCE 1907

NEW

ALU-INOX
3-PLY

FINITURA
MARTELLATA
HAMMERED
FINISH



per tutti i piani di cottura
for all hobs



NEW

CASSERUOLA ALTA
CON DUE MANIGLIE INOX

SAUCEPOT WITH
TWO STAINLESS STEEL HANDLES

Code	Ø cm	H cm	lt	IVA esc.
ALUM104M16	16	11,4	2,3	101,20 €
ALUM104M20	20	13,4	4,2	125,67 €
ALUM104M24	24	15,8	7,1	153,04 €



NEW

CASSERUOLA BASSA
CON DUE MANIGLIE INOX

CASSEROLE POT WITH
TWO STAINLESS STEEL HANDLES

Code	Ø cm	H cm	lt	IVA esc.
ALUM106M20	20	8,1	2,7	119,10 €
ALUM106M24	24	9,9	4,7	127,34 €
ALUM106M28	28	10,9	7,0	159,22 €

ACCIAIO INOX 18/10
18/10 STAINLESS STEEL

PER UNA FACILE PULIZIA
FOR EASY CLEANING

ALLUMINIO 1050
ALUMINUM 1050

PER UNA PERFETTA TRASMISSIONE DEL CALORE
FOR PERFECT HEAT DISTRIBUTION

ACCIAIO FERRITICO
FERRITIC STEEL

PER L'INDUZIONE
FOR INDUCTION COOKING

ALU-INOX 3PLY

FINITURA MARTELLATA HAMMERED FINISH

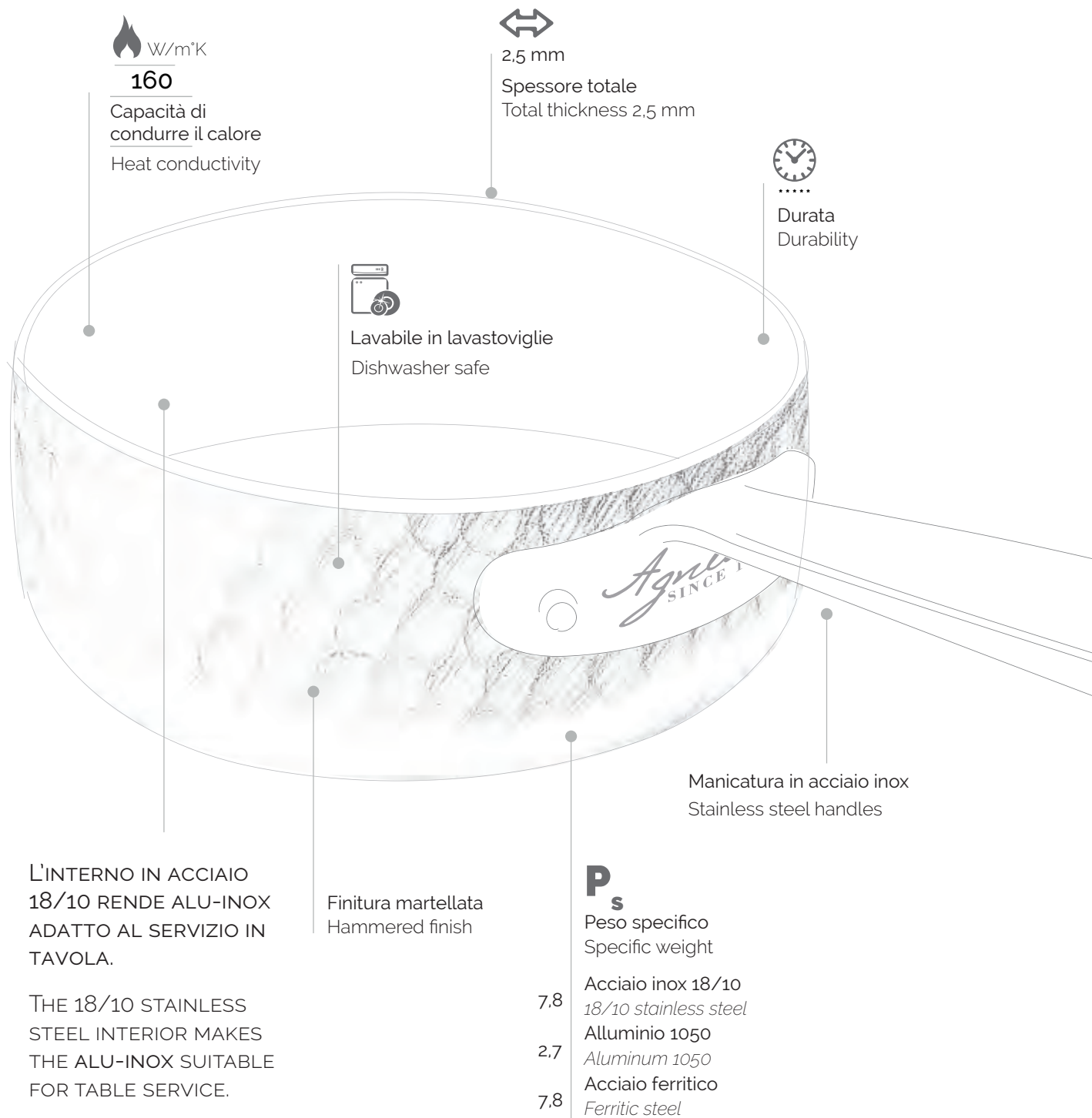

ALU-INOX
3-PLY

AGNELLI SINCE 1907



NEW

CASSERUOLA ALTA
CON UN MANICO INOX

SAUCEPOT
WITH A STAINLESS STEEL HANDLE



Code	Ø cm	H cm	lt	IVA esc.
ALUM105M16	16	11,4	2,3	79,12 €



NEW

CASSERUOLA BASSA
CON UN MANICO INOX

CASSEROLE PAN
WITH A STAINLESS STEEL HANDLE



Code	Ø cm	H cm	lt	IVA esc.
ALUM107M20	20	8,1	2,7	95,15 €



NEW

TEGAME CON DUE MANIGLIE

OMELETTE PAN WITH TWO HANDLES

Code	Ø cm	H cm	IVA esc.
ALUM110M24	24	6,3	112,28 €
ALUM110M28	28	6,3	130,83 €



NEW

PADELLA CON UN MANICO

PAN WITH ONE HANDLE



Code	Ø cm	H cm	IVA esc.
ALUM111M24	24	6,3	95,74 €
ALUM111M28	28	6,3	111,37 €



COPERCHIO IN ACCIAIO LUCIDO
CON POMOLO

POLISHED STEEL LID WITH KNOB

Code	Ø cm	IVA esc.
ALUM12916	16	35,69 €
ALUM12920	20	38,53 €
ALUM12924	24	42,48 €
ALUM12928	28	45,87 €

Agnelli
SINCE 1907

ALU-INOX
3-PLY

FINITURA
LUCIDA
MIRROR FINISH



per tutti i piani di cottura
for all hobs



NEW

NUOVA MISURA 16cm
NEW SIZE 16cm

**CASSERUOLA ALTA
CON DUE MANIGLIE INOX**

SAUCEPOT WITH
TWO STAINLESS STEEL HANDLES

Code	Ø cm	H cm	lt	IVA esc.
ALUM10416	16	11.4	2.3	96.85 €
ALUM10420	20	13.4	4.2	106.80 €
ALUM10424	24	15.8	7.1	131.19 €
ALUM10428	28	18.1	11.1	163.58 €
ALUM10432	32	20.1	16.2	186.39 €
ALUM10436	36	22.1	22.5	236.98 €
ALUM10440	40	21.1	26.5	351.09 €



**CASSERUOLA BASSA
CON DUE MANIGLIE INOX**

CASSEROLE POT WITH
TWO STAINLESS STEEL HANDLES

Code	Ø cm	H cm	lt	IVA esc.
ALUM10620	20	8.1	2.7	103.97 €
ALUM10624	24	9.9	4.5	108.57 €
ALUM10628	28	10.9	6.7	136.99 €
ALUM10632	32	12.2	9.8	187.65 €
ALUM10636	36	13.3	13.5	203.91 €
ALUM10640	40	14.1	17.7	294.00 €



ACCIAIO INOX 18/10
18/10 STAINLESS STEEL

PER UNA FACILE PULIZIA
FOR EASY CLEANING

ALLUMINIO 1050
ALUMINUM 1050

PER UNA PERFETTA TRASMISSIONE DEL CALORE
FOR PERFECT HEAT DISTRIBUTION

ACCIAIO FERRITICO
FERRITIC STEEL

PER L'INDUZIONE
FOR INDUCTION COOKING

ALU-INOX 3PLY

FINITURA LUCIDA MIRROR FINISH

W/m²K**160**

Capacità di
condurre il calore

Heat conductivity

Finitura lucida
Mirror finish

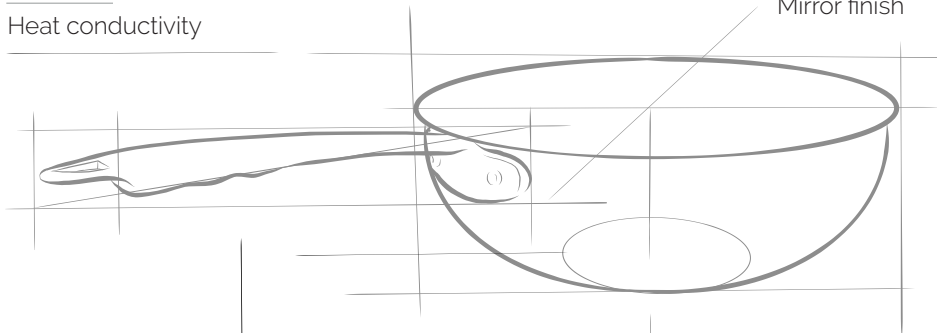

Manicatura
in acciaio inox
Stainless steel handles

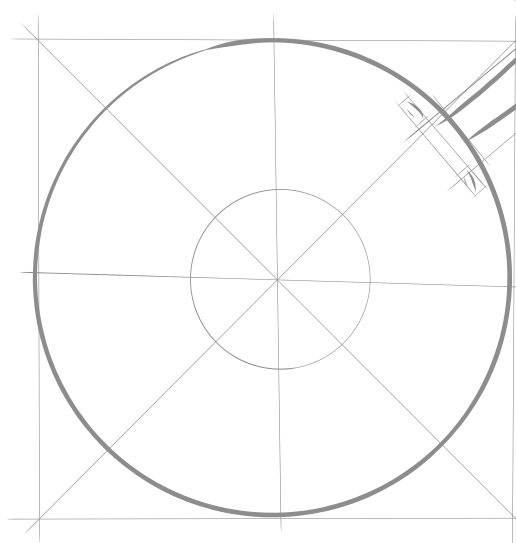

Durata
Durability



per tutti i piani di cottura
for all hobs



2,5 mm

Spessore totale
Total thickness 2,5 mm

L'INTERNO IN ACCIAIO
18/10 RENDE ALU-INOX
ADATTO AL SERVIZIO IN
TAVOLA.

THE 18/10 STAINLESS
STEEL INTERIOR MAKES
THE ALU-INOX SUITABLE
FOR TABLE SERVICE.

P_s

Peso specifico
Specific weight

7.8
Acciaio inox 18/10
18/10 stainless steel

2.7
Alluminio 1050
Aluminum 1050

7.8
Acciaio ferritico
Ferritic steel

ALU-INOX
3-PLY

AGNELLI SINCE 1907



CASSERUOLA ALTA
CON UN MANICO INOX

SAUCEPAN
WITH A STAINLESS STEEL HANDLE



Code	Ø cm	H cm	lt	IVA esc.
ALUM10516	16	11,4	2,3	69,58 €
ALUM10520	20	13,4	4,2	107,10 €



CASSERUOLA ALTA SALSIERA
CON UN MANICO E DUE BECCUCCI

SAUCEPAN WITH A STAINLESS STEEL
HANDLE AND TWO SPOUTS



Code	Ø cm	H cm	lt	IVA esc.
ALUM10512	12	6,3	0,7	54,13 €
ALUM10514	14	7,3	1,1	59,74 €



CASSERUOLA BASSA
CON UN MANICO INOX

CASSEROLE PAN
WITH A STAINLESS STEEL HANDLE



Code	Ø cm	H cm	lt	IVA esc.
ALUM10720	20	8,1	2,7	88,13 €
ALUM10724	24	9,8	4,4	105,77 €
ALUM10728	28	11	6,8	124,94 €



TEGAME CON DUE MANIGLIE

OMELETTE PAN WITH TWO HANDLES



Code	Ø cm	H cm	IVA esc.
ALUM11028	28	6	112,24 €
ALUM11032	32	6,5	130,68 €
ALUM11036	36	7	155,82 €
ALUM11040	40	7,2	268,17 €

ALU-INOX 3-PLY

AGNELLI SINCE 1907



PADELLA SVASATA ALTA "SALTAPASTA" CON UN MANICO

SAUTÈ PAN "PASTA" WITH ONE HANDLE

Code	Ø cm	H cm	IVA esc.
ALUM111B20	20	5.5	62,57 €
ALUM111B24	24	6,9	77,16 €
ALUM111B28	28	6,9	89,45 €
ALUM111B32	32	7,4	105,30 €



PADELLA CON UN MANICO

FRYPAN WITH ONE HANDLE

Code	Ø cm	H cm	IVA esc.
ALUM11120	20	4.3	59,84 €
ALUM11124	24	4.5	76,74 €
ALUM11128	28	5	87,43 €
ALUM11132	32	6	102,96 €





“ L'ultimo gesto, preciso e consapevole,
in cui tecnica e sensibilità si fondono
per esaltare ogni sapore,

fino all'armonia assoluta. ”

MANTECARE

“ The final gesture – precise and intentional
– where technique and sensitivity merge to
enhance every flavor,

culminating in perfect harmony. ”



NEW

NUOVA MISURA 20cm
NEW SIZE 20cm

PADELLA “MANTECARE” CON UN MANICO

“MANTECARE” PAN
WITH ONE HANDLE

Code	Ø cm	H cm	IVA esc.
ALUM111BM20	20	7,8	77,90 €
ALUM111BM24	24	8,7	90,53 €
ALUM111BM28	28	10,2	103,16 €



COPERCHIO IN ACCIAIO LUCIDO CON POMOLO

POLISHED STEEL LID WITH KNOB

Code	Ø cm	IVA esc.
ALUM12916	16	35,69 €
ALUM12920	20	38,53 €
ALUM12924	24	42,48 €
ALUM12928	28	45,87 €
ALUM12932	32	52,96 €
ALUM12936	36	59,87 €
ALUM12940	40	69,24 €

Agnelli
SINCE 1907

NEW

NON-STICK
ALU-INOXFINITURA
LUCIDA
MIRROR FINISHper tutti i piani di cottura
for all hobsANTIADERENTE NO PFAS
NON-STICK, PFAS-FREE

NEW

CASSERUOLA ALTA
CON DUE MANIGLIE INOXSAUCEPOT WITH
TWO STAINLESS STEEL HANDLES

Code	Ø cm	H cm	lt	IVA esc.
ALUM04K16	16	11,4	2,3	78,27 €
ALUM04K20	20	13,4	4,2	92,22 €
ALUM04K24	24	16,4	7,4	116,43 €



NEW

CASSERUOLA ALTA
CON UN MANICO INOXSAUCEPAN
WITH A STAINLESS STEEL HANDLE

Code	Ø cm	H cm	lt	IVA esc.
ALUM05K16	16	11,4	2,3	58,02 €
ALUM05K20	20	13,4	4,2	71,24 €

ANTIADERENTE CK3000
NON-STICK CK3000PER UNA FACILE PULIZIA
FOR EASY CLEANINGALLUMINIO 1050
ALUMINUM 1050PER UNA PERFETTA TRASMISSIONE DEL CALORE
FOR PERFECT HEAT DISTRIBUTIONACCIAIO FERRITICO
FERRITIC STEELPER L'INDUZIONE
FOR INDUCTION COOKING

NON-STICK ALU-INOX

FINITURA LUCIDA

MIRROR FINISH



ANTIADERENTE NO PFAS
NON-STICK, PFAS-FREE



Durata
Durability

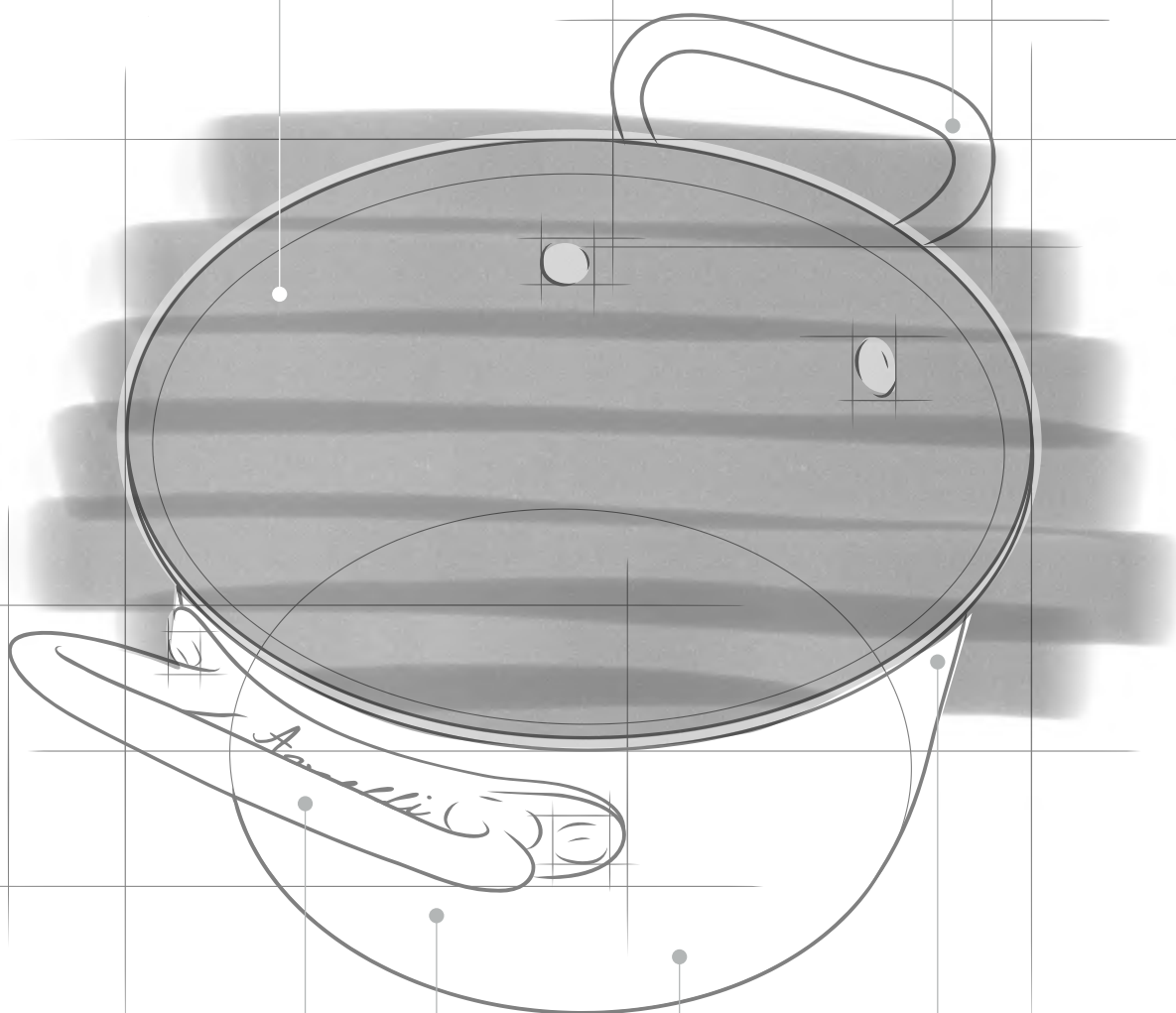

Manicatura
in acciaio inox
Stainless steel handles

Finitura lucida
Mirror finish



2.5 mm
Spessore totale
Total thickness 2.5 mm



W/m²K

160

Capacità di
condurre il calore
Heat conductivity

NON-STICK
ALU-INOX

AGNELLI SINCE 1907

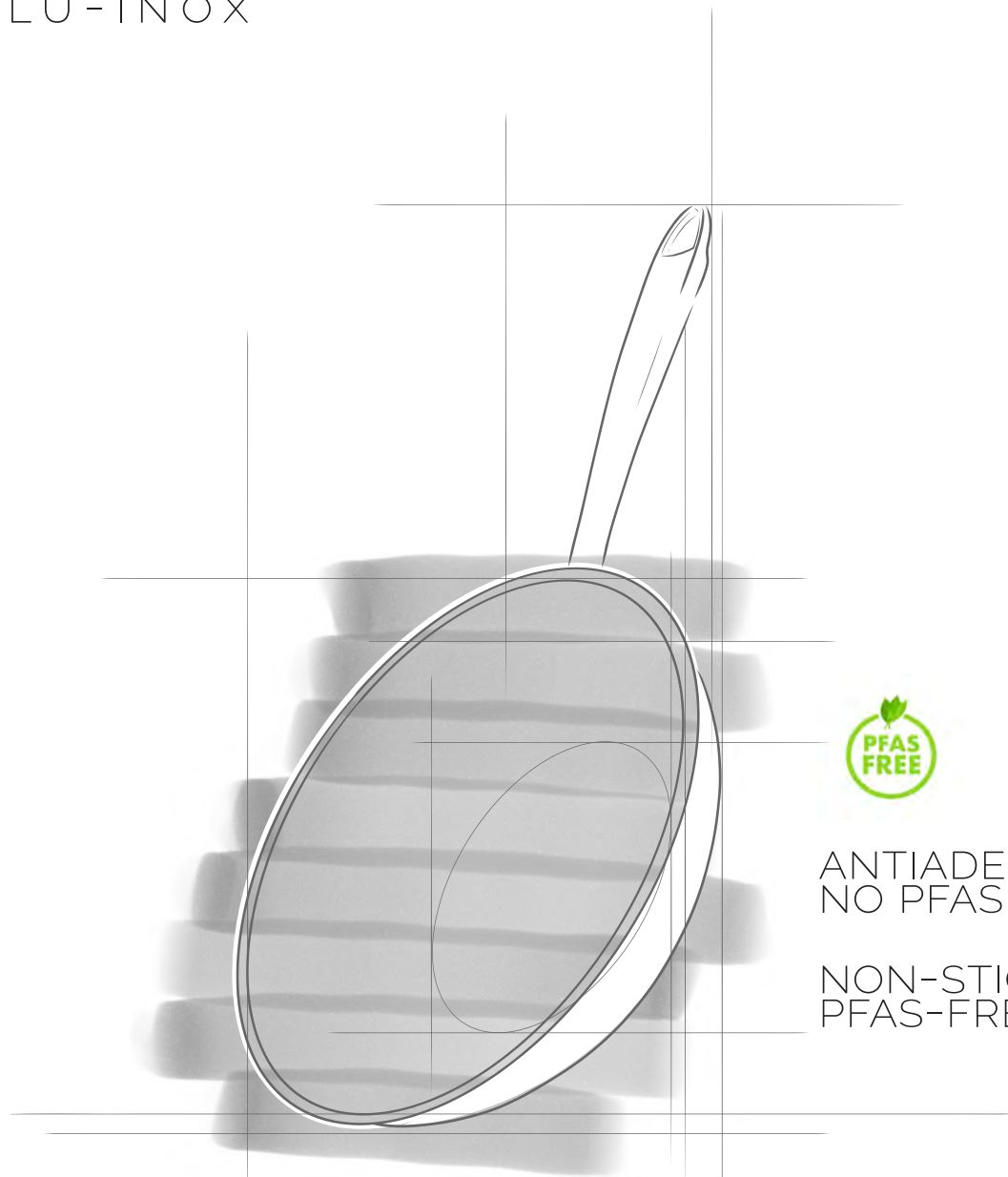

ANTIADERENTE
NO PFAS

NON-STICK,
PFAS-FREE



NEW

RONDEAU CON DUE
MANIGLIE

RONDEAU WITH TWO
STAINLESS STEEL HANDLES

Code	Ø cm	H cm	IVA esc.
ALUM012K28	28	7,5	104,00 €
ALUM012K32	32	8	121,74 €



NEW

PADELLA SVASATA ALTA
"SALTAPASTA" CON UN MANICO

SAUTÉ PAN "PASTA" WITH ONE HANDLE



Code	Ø cm	H cm	IVA esc.
ALUM011BK20	20	5.9	51.89 €
ALUM011BK24	24	6.3	63.22 €
ALUM011BK28	28	6.9	76.32 €
ALUM011BK32	32	7.4	92.33 €



ANTIADERENTE NO PFAS
NON-STICK, PFAS-FREE



NEW

PADELLA
CON UN MANICO

LOW SAUTÉ PAN WITH ONE HANDLE



Code	Ø cm	H cm	IVA esc.
ALUM011K20	20	4.2	50.10 €
ALUM011K24	24	5	59.80 €
ALUM011K28	28	5.4	72.57 €
ALUM011K32	32	5.6	85.74 €

Agnelli
SINCE 1907

ALU-INOX
3-PLY

FINITURA
SATINATA
SATIN FINISH



per tutti i piani di cottura
for all hobs



**CASSERUOLA ALTA
CON DUE MANIGLIE**

SAUCEPOT WITH
TWO STAINLESS STEEL HANDLES



Code	Ø cm	H cm	lt	IVA esc.
ALIX104ALIN16	16	11,4	2,3	81,38 €
ALIX104ALIN20	20	13,4	4,2	94,70 €
ALIX104ALIN24	24	16,4	7,4	122,07 €
ALIX104ALIN28	28	18,3	11,3	143,89 €
ALIX104ALIN32	32	20,3	16,3	164,20 €
ALIX104ALIN36	36	22	22,4	205,27 €
ALIX104ALIN40	40	23	28,9	266,46 €



**CASSERUOLA BASSA
CON DUE MANIGLIE**

CASSEROLE POT WITH
TWO STAINLESS STEEL HANDLES



Code	Ø cm	H cm	lt	IVA esc.
ALIX106ALIN16	16	8	1,6	74,11 €
ALIX106ALIN20	20	8,3	2,6	88,93 €
ALIX106ALIN24	24	9,5	4,3	96,04 €
ALIX106ALIN28	28	11	6,8	123,79 €
ALIX106ALIN32	32	12,4	10,0	155,05 €
ALIX106ALIN36	36	13,2	13,4	176,86 €
ALIX106ALIN40	40	14	17,6	215,08 €

ACCIAIO INOX 18/10
18/10 STAINLESS STEEL

PER UNA FACILE PULIZIA
FOR EASY CLEANING

ALLUMINIO 1050
ALUMINUM 1050

PER UNA PERFETTA TRASMISSIONE DEL CALORE
FOR PERFECT HEAT DISTRIBUTION

ACCIAIO FERRITICO
FERRITIC STEEL

PER L'INDUZIONE
FOR INDUCTION COOKING

ALU-INOX 3PLY

FINITURA SATINATA SATIN FINISH



2.5 mm

Spessore totale
Total
thickness 2.5 mm

W/m²K

160

Capacità di
condurre il calore
Heat
conductivity

Finitura satinata
Satin finish

Rivetti in acciaio inox
Stainless steel rivets

Lavabile in lavastoviglie
Dishwasher safe

L'INTERNO IN ACCIAIO
18/10 RENDE ALU-INOX
ADATTO AL SERVIZIO IN
TAVOLA.

THE 18/10 STAINLESS
STEEL INTERIOR MAKES
THE ALU-INOX SUITABLE
FOR TABLE SERVICE.

Bordo
salvaschizzo
Splash-saving
edge



.....

Durata
Durability

Manicatura
in acciaio inox
Stainless steel
handles

P_s

Peso specifico
Specific weight

7.8 Acciaio inox 18/10
18/10 stainless steel
2.7 Alluminio 1050
Aluminum 1050
7.8 Acciaio ferritico
Ferritic steel



per tutti i piani di cottura
for all hobs

ALU-INOX 3-PLY

AGNELLI SINCE 1907



CASSERUOLA ALTA CON UN MANICO

SAUCEPAN
WITH ONE HANDLE



Code	Ø cm	H cm	lt	IVA esc.
ALIX105ALIN16	16	11,4	2,3	61,78 €
ALIX105ALIN20	20	13,4	4,2	75,60 €
ALIX105ALIN24	24	16,4	7,4	96,31 €
ALIX105ALIN28	28	18,3	11,3	119,52 €



CASSERUOLA BASSA CON UN MANICO

CASSEROLE PAN
WITH ONE HANDLE



Code	Ø cm	H cm	lt	IVA esc.
ALIX107ALIN16	16	8	1,6	54,51 €
ALIX107ALIN20	20	8,3	2,6	68,23 €
ALIX107ALIN24	24	9,5	4,3	70,28 €
ALIX107ALIN28	28	11	6,8	99,43 €



TEGAME CON DUE MANIGLIE

OMELETTE PAN WITH TWO HANDLE



Code	Ø cm	H cm	IVA esc.
ALIX110ALIN20	20	6,3	77,22 €
ALIX110ALIN24	24	6,3	85,10 €
ALIX110ALIN28	28	6,3	101,31 €
ALIX110ALIN32	32	6,8	114,86 €
ALIX110ALIN36	36	7,2	136,94 €



PADELLA SVASATA ALTA
"SALTAPASTA" CON UN MANICO

SAUTÈ PAN "PASTA" WITH ONE HANDLE



Code	Ø cm	H cm	IVA esc.
ALIX111BALIN20	20	5.9	56.29 €
ALIX111BALIN24	24	6.3	65.42 €
ALIX111BALIN28	28	6.9	76.64 €
ALIX111BALIN32	32	7.4	98.34 €



PADELLA
CON UN MANICO

FRYPAN WITH ONE HANDLE



Code	Ø cm	H cm	IVA esc.
ALIX111ALIN20	20	4.2	53.35 €
ALIX111ALIN24	24	5	64.23 €
ALIX111ALIN28	28	5.4	75.11 €
ALIX111ALIN32	32	5.6	88.54 €
ALIX111ALIN36	36	5.8	103.80 €



COPERCHIO IN ACCIAIO LUCIDO
CON POMOLO

POLISHED STEEL LID WITH KNOB

Code	Ø cm	IVA esc.
ALUM12916	16	35.69 €
ALUM12920	20	38.53 €
ALUM12924	24	42.48 €
ALUM12928	28	45.87 €
ALUM12932	32	52.96 €
ALUM12936	36	59.87 €
ALUM12940	40	69.24 €

Agnelli
SINCE 1907

INDUCTION
CHEF

2-PLY

DUE



per tutti i piani di cottura
for all hobs

Il rivestimento Agnelli Shark Skin è 3 volte più spesso di un normale antiaderente.

The Agnelli Shark Skin coating is 3 times thicker than a normal non-stick.



NEW

PADELLA SVASATA ALTA
CON UN MANICO

SAUTÉ PAN
WITH ONE HANDLE

Code	Ø cm	H cm	IVA esc.
ALIX011BG20	20	5,9	96,29 €
ALIX011BG24	24	6,3	108,06 €
ALIX011BG28	28	6,9	123,13 €
ALIX011BG32	32	7,4	139,06 €



NEW

PADELLA SVASATA BASSA
CON UN MANICO

LOW SAUTÉ PAN
WITH ONE HANDLE



Code	Ø cm	H cm	IVA esc.
ALIX011G20	20	4,2	95,68 €
ALIX011G24	24	5	107,02 €
ALIX011G28	28	5,4	121,80 €
ALIX011G32	32	5,6	136,22 €

ANTIADERENTE SHARK SKIN PER UNA FACILE PULIZIA E UNA MASSIMA DURATA
NON-STICK SHARK SKIN FOR EASY CLEANING AND MAXIMUM DURABILITY

ALLUMINIO 1050 PER UNA PERFETTA TRASMISSIONE DEL CALORE
ALUMINUM 1050 FOR PERFECT HEAT DISTRIBUTION

ACCIAIO FERRITICO PER L'INDUZIONE
FERRITIC STEEL FOR INDUCTION COOKING

110 μm

Shark Skin

40 μm

Normale antiaderente

Normal non-stick



PFOA
FREE

Rivestimento
protettivo

20 μm

Topcoat

Rinforzo
intermedio

15 μm

Midcoat

Fondo
rinforzato

75 μm

Primer

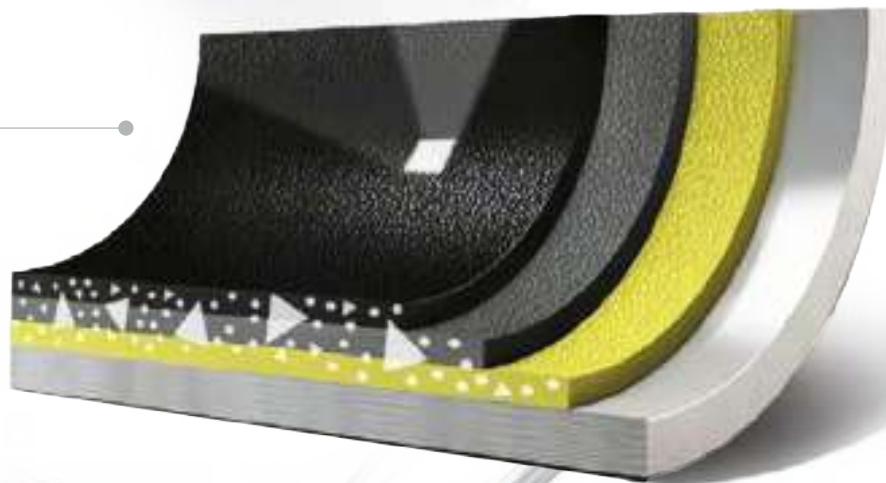

Manicatura
in acciaio inox
Stainless steel
handles



Lavabile in lavastoviglie

Dishwasher safe



3 mm

Spessore totale

Total thickness 3 mm

Rivetti in acciaio inox
Stainless steel rivets

P_s Peso specifico
Specific weight

2.7 Alluminio 1050

Acciaio ferritico

7.8 Ferritic steel

Bordo
salvaschizzo
Splash-saving
edge

Finitura satinata
Satin finish



$\text{W/m}^2\text{K}$

185

Capacità di
condurre il calore
Heat
conductivity

INDUCTION CHEF
2-PLY

AGNELLI SINCE 1907

PFOA
FREERivestimento
protettivo20 μm

Topcoat

Rinforzo
intermedio15 μm

Midcoat

Fondo
rinforzato75 μm

Primer

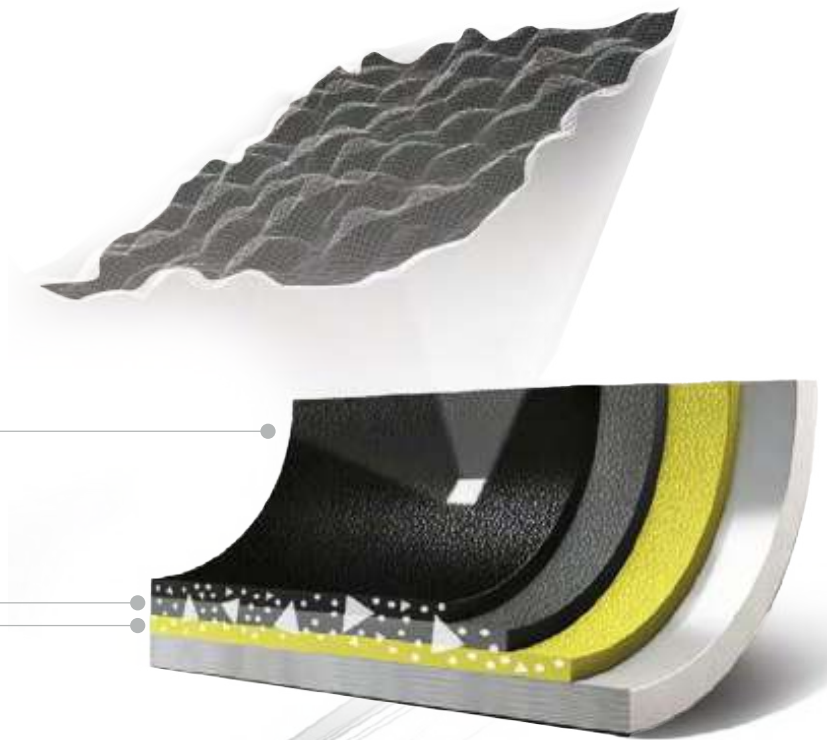
Manicatura
in acciaio inox
Stainless steel
handlesLavabile in lavastoviglie
Dishwasher safe**P_s**Peso specifico
Specific weight

Alluminio 1050

2.7 Aluminum 1050

Acciaio ferritico

7.8 Ferritic steel

Capacità di
condurre il calore
Heat
conductivity**185**

3 mm

Spessore totale

Total thickness 3 mm

Rivetti in acciaio inox
Stainless steel rivets



PADELLA SVASATA ALTA
"SALTAPASTA" CON UN MANICO

SAUTÉ PAN "PASTA" WITH ONE HANDLE

Code	Ø cm	H cm	IVA esc.
ALSA6111BG20	20	5,7	81,42 €
ALSA6111BG24	24	6,4	92,99 €
ALSA6111BG28	28	6,6	105,57 €
ALSA6111BG32	32	7,2	121,52 €

110 µm

Shark Skin

40 µm

Normale antiaderente
Normal non-stick



PADELLA SVASATA BASSA
CON UN MANICO

LOW SAUTÉ PAN WITH ONE HANDLE

Code	Ø cm	H cm	IVA esc.
ALSA6111BBG24	24	4,7	92,00 €
ALSA6111BBG28	28	5,3	104,31 €
ALSA6111BBG32	32	5,6	118,55 €



per tutti i piani di cottura
for all hobs

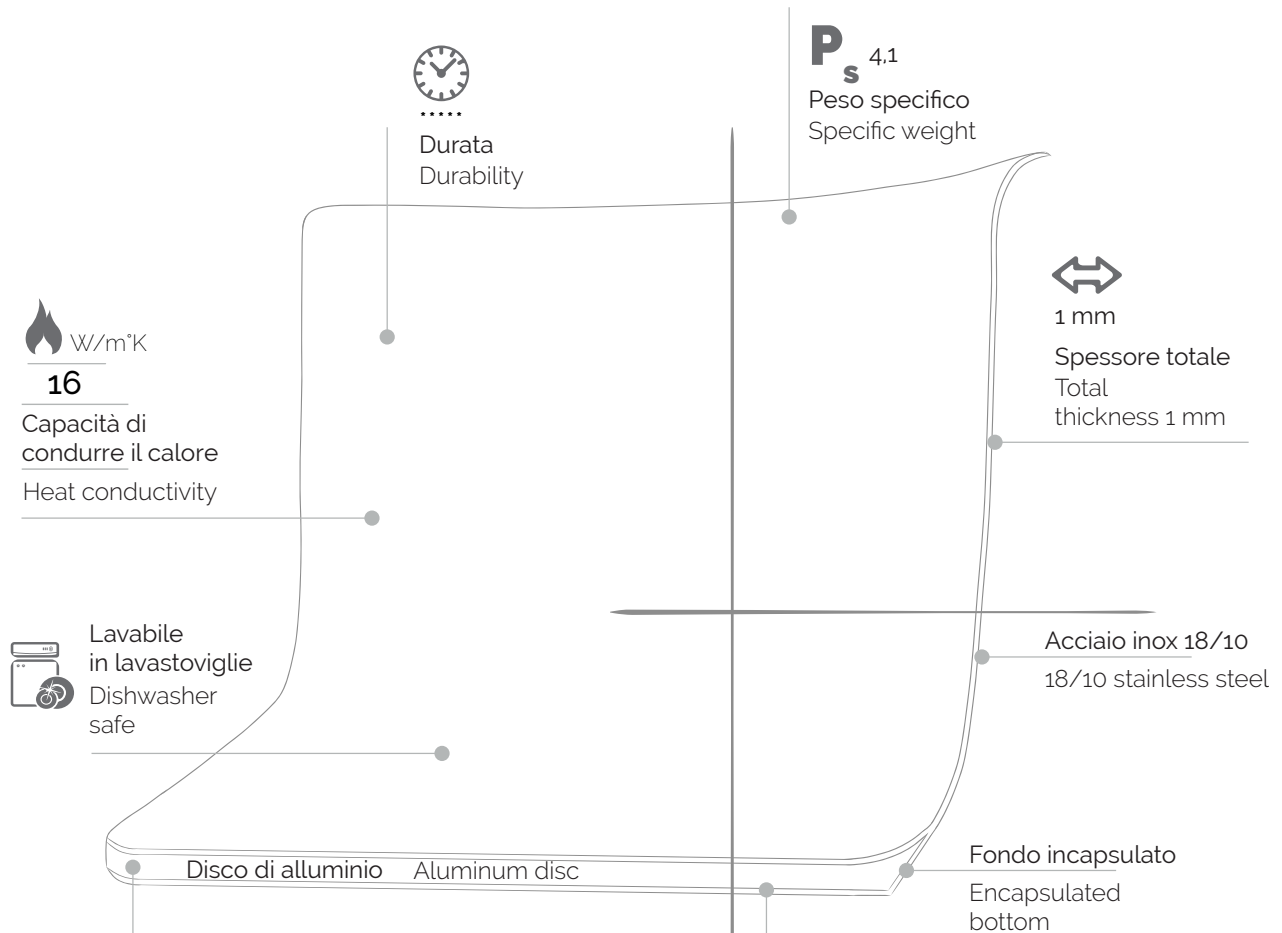

Alluminio

La presenza di alluminio di alto spessore nel fondo delle nostre pentole in acciaio garantisce una distribuzione del calore più rapida e uniforme. L'alluminio, infatti, assorbe e diffonde il calore dal disco in acciaio ferritico alla base, migliorando le performance rispetto alla sola struttura in acciaio inox 18/10.

Aluminum

The use of thick aluminum in the base of our steel pans ensures faster and more even heat distribution. The aluminum absorbs and diffuses heat from the ferritic steel disc to the base, improving performance compared to 18/10 stainless steel alone.

Acciaio ferritico per induzione

Ferritic steel for induction



per tutti i piani di cottura
for all hobs



**PENTOLA
CON DUE MANIGLIE**

STOCKPOT WITH TWO
STAINLESS STEEL HANDLES

Code	Ø cm	Ø disco ind. cm	H cm	lt	IVA esc.
COIX3103E20	20	18	20	4,4	€ 59,06
COIX3103E24	24	21,5	24	10,9	€ 70,23
COIX3103E28	28	24,7	28	17,2	€ 102,09
COIX3103E32	32	26,5	32	25,7	€ 133,70
COIX3103E36	36	30,5	36	36,6	€ 168,85
COIX3103E40	40	34	40	50,3	€ 212,85
COIX3103E45	45	37,5	45	71,6	€ 312,55
COIX3103E50	50	41	50	98,2	€ 477,93



**CASSERUOLA ALTA
CON DUE MANIGLIE**

SAUCEPOT WITH TWO
STAINLESS STEEL HANDLES



Code	Ø cm	Ø disco ind. cm	H cm	lt	IVA esc.
COIX3104E16	16	14,5	10,5	2,1	€ 43,24
COIX3104E18	18	16	12	3,1	€ 46,71
COIX3104E20	20	18	14	4,4	€ 52,02
COIX3104E24	24	21,8	16	7,2	€ 63,29
COIX3104E28	28	25	18	11,1	€ 84,86
COIX3104E32	32	27	20	16,1	€ 107,62
COIX3104E36	36	30,5	22	22,4	€ 133,73
COIX3104E40	40	33,9	25	31,4	€ 179,90
COIX3104E45	45	37,5	28	44,5	€ 266,06
COIX3104E50	50	41,2	32	62,8	€ 360,24
COIX3104E60	60	44,5	37	104,6	€ 661,09



**CASSERUOLA BASSA
CON DUE MANIGLIE**

CASSEROLE POT WITH TWO
STAINLESS STEEL HANDLES

Code	Ø cm	Ø disco ind. cm	H cm	lt	IVA esc.
COIX3106E16	16	14	7,5	1,5	€ 39,92
COIX3106E20	20	18	10,5	3,3	€ 49,09
COIX3106E24	24	21,5	11	5,0	€ 56,25
COIX3106E28	28	25	13	8,0	€ 76,73
COIX3106E32	32	27	16	12,9	€ 98,95
COIX3106E36	36	30,5	18	18,3	€ 124,41
COIX3106E40	40	34	19	23,9	€ 154,22
COIX3106E45	45	37	21	33,4	€ 230,51
COIX3106E50	50	41	23	45,2	€ 311,90
COIX3106E60	60	44	25	70,7	€ 587,50



**CASSERUOLA ALTA
CON UN MANICO**

SAUCEPAN
WITH A STAINLESS STEEL HANDLE

Code	Ø cm	Ø disco ind. cm	H cm	lt	IVA esc.
COIX3105E12*	12	10,3	7	0,8	€ 28,83
COIX3105E14*	14	12,2	8	1,2	€ 33,60
COIX3105E16	16	14	10,5	2,1	€ 38,58
COIX3105E18	18	16	12	3,1	€ 42,59
COIX3105E20	20	18	14	4,4	€ 45,73
COIX3105E24	24	21,5	16	7,2	€ 60,36
COIX3105E28	28	25	18	11,1	€ 86,48



**CASSERUOLA BASSA
CON UN MANICO**

CASSEROLE PAN WITH TWO
STAINLESS STEEL HANDLES

Code	Ø cm	Ø disco ind. cm	H cm	lt	IVA esc.
COIX3107E16	16	14	7,5	1,5	€ 36,85
COIX3107E20	20	18	10,5	3,3	€ 42,70
COIX3107E24	24	21,5	11	5,0	€ 52,89
COIX3107E28	28	25	13	8,0	€ 78,46



CASSERUOLA CONICA CON UN MANICO

CONICAL CASSEROLE PAN, 1 HANDLE

Code	Ø cm	Ø disco ind. cm	H cm	IVA esc.
COIX3109E16	16	11	6	€ 41,83
COIX3109E18	18	13,3	6	€ 46,49
COIX3109E20	20	14,5	6,5	€ 51,04
COIX3109E22	22	17	7	€ 56,14
COIX3109E24	24	18,2	7,5	€ 61,02



PADELLA CON UN MANICO

FRYING PAN WITH ONE HANDLE
TUBULAR STAINLESS STEEL

Code	Ø cm	Ø disco ind. cm	H cm	IVA esc.
COIX3111E20	20	15	4,5	€ 39,99
COIX3111E24	24	18,5	5	€ 48,12
COIX3111E28	28	22	5	€ 56,15
COIX3111E32	32	25,2	5	€ 73,77
COIX3111E36	36	29	6	€ 103,16
COIX3111E40	40	32	7	€ 139,80



**PADELLA CON UN MANICO
E RIVESTIMENTO INTERNO PLATINUM**

FRYING PAN WITH A STAINLESS STEEL TUBULAR
HANDLE AND PLATINUM INTERNAL COATING

Code	Ø cm	Ø disco ind. cm	H cm	IVA esc.
COIX3111SP20	20	15	4,5	€ 46,05
COIX3111SP24	24	15	5	€ 64,37
COIX3111SP28	28	18,5	5	€ 80,96
COIX3111SP32	32	22	5	€ 99,38
COIX3111SP36	36	25,2	6	€ 122,36
COIX3111SP40	40	29	7	€ 156,13



TEGAME CON DUE MANIGLIE

STAINLESS STEEL OMELETTE PAN
WITH TWO HANDLES

Code	Ø cm	Ø disco ind. cm	H cm	IVA esc.
COIX3110E20	20	14,7	4,5	€ 41,74
COIX3110E24	24	18,5	5	€ 50,29
COIX3110E28	28	22	5	€ 62,91
COIX3110E32	32	25	5	€ 76,89
COIX3110E36	36	29	6	€ 113,02
COIX3110E40	40	31,3	7	€ 149,29



**TEGAME CON DUE MANIGLIE
E RIVESTIMENTO INTERNO PLATINUM**

OMELETTE PAN WITH A STAINLESS
STEEL TUBULAR HANDLE AND PLATINUM
INTERNAL COATING

Code	Ø cm	Ø disco ind. cm	H cm	IVA esc.
COIX3110SP20	20	14,7	4,5	€ 49,64
COIX3110SP24	24	15	5	€ 59,63
COIX3110SP28	28	18,5	5	€ 73,00
COIX3110SP32	32	22	5	€ 96,90
COIX3110SP36	36	25,2	6	€ 125,88
COIX3110SP40	40	29	7	€ 155,40



COLAPASTA A SPICCHIO CON UN MANICO

SEGMENT COLANDER

Code	Ø cm	H cm	IVA esc.
COIX3153BE36	36	23	€ 55,29
COIX3153BE40	40	26	€ 66,00



CASSERUOLA CON 4 SCOMPARTI COLAPASTA A SPICCHIO CON DUE MANIGLIE

SAUCEPOT WITH 4 SEGMENT COLANDERS

Code	Ø cm	Ø disco ind. cm	H cm	lt	IVA esc.
COIX3153E36	36	30,5	22	21	€ 403,43
COIX3153E40	40	33,9	25	31	€ 486,24



COPERCHIO

LID

Code	Ø cm	IVA esc.
COIX3129E16	16	€ 11,92
COIX3129E18	18	€ 12,79
COIX3129E20	20	€ 13,98
COIX3129E24	24	€ 17,01
COIX3129E28	28	€ 20,05
COIX3129E32	32	€ 24,93
COIX3129E36	36	€ 29,37
COIX3129E40	40	€ 35,98
COIX3129E45	45	€ 46,61
COIX3129E50	50	€ 54,60
COIX3129E60	60	€ 91,81



COLAPASTA SFERICO CON DUE MANIGLIE

SPHERICAL COLANDER

Code	Ø cm	H cm	IVA esc.
COIX311532	32	18	€ 170,15
COIX311536	36	19	€ 206,58
COIX311540	40	21	€ 246,80



SCALDAPASTA CILINDRICO CON UN MANICO

PASTA HEATER, 1 HANDLE

Code	Ø cm	H cm	IVA esc.
COIX317518	18	11	€ 65,60
COIX317520	20	12	€ 71,49
COIX317522	22	13	€ 79,21
COIX317524	24	14	€ 90,21
COIX317528	28	16	€ 113,03



IMBUTO

FUNNEL

Code	Ø cm	IVA esc.
COIX309912	12	€ 27,78
COIX309914	14	€ 34,45
COIX309920	20	€ 61,22
COIX309925	25	€ 74,40
COIX309930	30	€ 91,19



CHINOISE INOX CON UN MANICO INOX

PROFESSIONAL CHINESE COLANDER

Code	cm	lung. totale	IVA esc.
COIX3232E18	18	37,8	€ 19,91
COIX3232E20	20	39,5	€ 27,39
COIX3232E24	24	42,5	€ 35,20



BASTARDELLA SEMISFERICA CON
MANIGLIE INOX
NO INDUZIONE

HEMISPHERIC MIXING BOWL, 2 HANDLES

Code	Ø cm	H cm	IVA esc.
COIX320222	22	12	€ 59,09
COIX320226	26	14	€ 76,76
COIX320232	32	18	€ 98,70
COIX320236	36	20	€ 147,79
COIX320240	40	21	€ 155,97



BASE PER BASTARDELLA

MIXING BOWL BASE

Code	Ø cm	H cm	IVA esc.
COIX3202B16	16	22	€ 33,09
		26	
COIX3202B22	22	32	€ 58,86
		36	
		40	



MESTOLO INOX

ONE-PIECE LADLE

Code	Ø cm	lung. totale cm*	lt	IVA esc.
COIX3205E06	6	36	0,07	€ 11,22
COIX3205E08	8	41	0,12	€ 12,99
COIX3205E10	10	47	0,25	€ 18,46
COIX3205E12	12	51	0,5	€ 23,37
COIX3205E14	14	53	0,75	€ 28,28
COIX3205E16	16	57	1	€ 34,35



SCHIUMAROLA A FILO STAGNATO INOX

FLUSH SKIMMER

Code	Ø cm	lung. totale cm*	IVA esc.
COIX3207R14	14	55	14,34 €
COIX3207R18	18	58,5	16,28 €
COIX3207R20	20	68,5	21,57 €



PINZE SPINAPESCE

FISH BONES REMOVERS FOR CHEFS

Code	lung. totale cm*	IVA esc.
COIX360415	13,5	€ 19,35



PALETTA LISCIA INOX

ONE-PIECE SPATULA

Code	cm	lung. totale cm*	IVA esc.
COIX3208EL54	14	53	€ 18,93



MESTOLO INOX

ONE-PIECE LADLE

Code	Ø cm	lungh. totale cm*	IVA esc.
COIX3207E10	10	42,5	€ 13,79
COIX3207E12	12	48	€ 16,27
COIX3207E14	14	52,8	€ 19,40
COIX3207E16	16	58	€ 24,07
COIX3207E18	18	63	€ 27,40
COIX3207E20	20	66,8	€ 32,19

FORCHETTONE A 3 DENTI INOX

ONE-PIECE FORK, 3 PRONGS

Code	cm	lungh. totale cm*	IVA esc.
COIX3369E-350	10,5	53,2	€ 16,13



PALETTA FORATA INOX

ONE-PIECE PERFORATED SPATULA

Code	cm	lungh. totale cm*	IVA esc.
COIX3208EP54	14	53	€ 18,93



FRUSTA INOX

EGG WHISK

Code	lungh. totale cm*	IVA esc.
COIX3601E25	25	€ 14,26
COIX3601E30	30	€ 14,96
COIX3601E35	35	€ 15,66
COIX3601E40	40	€ 16,59
COIX3601E50	50	€ 17,39
COIX3601E55	55	€ 16,73
COIX3601E60	60	€ 19,63



FORCHETTONE INOX
STAINLESS STEEL FORK

Code	cm	lung. totale cm*	IVA esc.
COIX3369E-250	10	48	€ 15,19



CUCCHIAIONE INOX
STAINLESS STEEL SPOON

Code	cm	lung. totale cm*	IVA esc.
COIX3217E46	6	46	€ 16,83



PINZE CHEF INOX
CHEF'S PINCERS

Code	lung. totale cm*	IVA esc.
COIX360330	30	€ 13,30
COIX360335	35	€ 19,23
COIX360340	40	€ 28,29

IRON

Agnelli
SINCE 1907

NEW

FERRO
IRON



per tutti i piani di cottura
for all hobs



Finitura interna martellata
Hammered interior finish



2 mm

Spessore totale
Total
thickness 2 mm



60

W/m²K
Capacità di
condurre il calore
Heat conductivity



NEW

STRUMENTO PER ROSOLATURA E FRITTURE

TOOL FOR SEARING AND FRYING

Code	Ø cm	H cm	IVA esc.
COFE11120	20	4.9	44,00 €
COFE11124	24	5.3	49,00 €
COFE11128	28	5.7	55,92 €
COFE11132	32	6.1	60,55 €

PER COTTURE ASCIUTTE AD ALTA TEMPERATURA

STRUMENTO DI COTTURA IN **FERRO NITRURATO** PROGETTATO PER **ROSOLATURA E FRITTURE AD ALTA TEMPERATURA**.

IL TRATTAMENTO SUPERFICIALE E LA MASSA DEL MATERIALE LO RENDONO IDONEO A **COTTURE ASCIUTTE**, SENZA UTILIZZO DI LIQUIDI, GARANTENDO STABILITÀ E PERFORMANCE NELLE PREPARAZIONI RAPIDE.

IL PRODOTTO È DESTINATO A **UTILIZZATORI PROFESSIONALI** E A **UTILIZZATORI DOMESTICI ESPERTI**, CONSAPEVOLI DELLE **LIMITAZIONI D'USO** INDICATE.

FOR DRY, HIGH-TEMPERATURE COOKING

NITRIDED IRON COOKING TOOL DESIGNED FOR **HIGH-TEMPERATURE SEARING AND FRYING**.

THE SURFACE TREATMENT AND THE MASS OF THE MATERIAL MAKE IT SUITABLE FOR **DRY COOKING**, WITHOUT THE USE OF LIQUIDS, ENSURING STABILITY AND PERFORMANCE IN FAST PREPARATIONS.

THIS PRODUCT IS INTENDED FOR **PROFESSIONAL USERS** AND **EXPERIENCED DOMESTIC USERS** WHO ARE AWARE OF THE STATED **USAGE LIMITATIONS**.

Le micro-incisioni sul fondo creano attrito e riducono il rischio che scivoli su piani lisci o a induzione.

The micro-grooves on the bottom increase friction, reducing the risk of sliding on smooth or induction cooktops.



NON IDONEO A:

- COTTURE CON ALIMENTI ACIDI (POMODORO, ACETO, VINO, AGRUMI)
 - MARINATURE E SALAMOIE
 - BRASATURE, STUFATURE, SALSE
 - COTTURE CON PRESENZA DI LIQUIDI
 - CONSERVAZIONE DEGLI ALIMENTI
- L'USO DIFFORME RENDE IL PRODOTTO **NON CONFORME ALLA DESTINAZIONE PREVISTA.**



NO lavastoviglie
NO Dishwasher

Manicatura in acciaio inox rivestito di PVD
PVD coated stainless steel handle

PREPARAZIONE E UTILIZZO
PRIMA DEL PRIMO UTILIZZO:

- LAVARE ACCURATAMENTE
- ASCIUGARE COMPLETAMENTE
- UNGERE LEGGERMENTE LA SUPERFICIE INTERNA CON OLIO ALIMENTARE

L'OLIATURA è CONSIGLIATA **PRIMA DI OGNI UTILIZZO**, IN PARTICOLARE DOPO IL LAVAGGIO.

DESTINAZIONE D'USO

- UTILIZZO PROFESSIONALE (HORECA)
- UTILIZZO DOMESTICO EVOLUTO

NON DESTINATO A USO DOMESTICO GENERICO O UNIVERSALE.

LE LIMITAZIONI D'USO SONO **INCISE IN MODO PERMANENTE SUL FONDO** DELLO STRUMENTO PER GARANTIRE:

- INFORMAZIONE CHIARA E DURATURA
- CORRETTA DESTINAZIONE D'USO
- UTILIZZO CONSAPEVOLE

NOT SUITABLE FOR:

- COOKING WITH ACIDIC FOODS (TOMATOES, VINEGAR, WINE, CITRUS FRUITS)
- MARINADES AND BRINES
- BRAISING, STEWING, SAUCES
- COOKING WITH THE PRESENCE OF LIQUIDS
- FOOD STORAGE

USE OUTSIDE THESE CONDITIONS RENDERS THE PRODUCT **NON-COMPLIANT WITH ITS INTENDED PURPOSE.**

PREPARATION AND USE

- BEFORE FIRST USE:
- WASH THOROUGHLY
 - DRY COMPLETELY
 - LIGHTLY OIL THE INNER SURFACE WITH FOOD-GRADE OIL

OILING IS RECOMMENDED BEFORE EACH USE, ESPECIALLY AFTER WASHING.

INTENDED USE

- PROFESSIONAL USE (Ho.Re.Ca.)
- ADVANCED DOMESTIC USE

NOT INTENDED FOR GENERAL OR UNIVERSAL HOUSEHOLD USE.

THE USAGE LIMITATIONS ARE PERMANENTLY ENGRAVED ON THE BOTTOM OF THE TOOL TO ENSURE:

- CLEAR AND LONG-LASTING INFORMATION
- CORRECT INTENDED USE
- INFORMED AND CONSCIOUS USE



per tutti i piani di cottura
for all hobs



NEW

NUOVA MISURA 16cm
NEW SIZE 16cm

**CASSERUOLA ALTA
CON DUE MANIGLIE**

SAUCEPOT WITH TWO
STAINLESS STEEL HANDLES

Code	Ø cm	H cm	lt	IVA esc.
COTE104CIT16	16	9,2	1,8	136,85 €
COTE104CIT20	20	12,4	3,9	189,26 €
COTE104CIT24	24	15,9	7,2	238,30 €



**CASSERUOLA BASSA
CON DUE MANIGLIE**

CASSEROLE POT
WITH TWO STAINLESS STEEL HANDLES

Code	Ø cm	H cm	lt	IVA esc.
COTE106CIT24	24	10,3	4,5	203,45 €
COTE106CIT28	28	12,3	7,4	248,60 €

ACCIAIO INOX 18/10
18/10 STAINLESS STEEL

PER UNA FACILE PULIZIA
FOR EASY CLEANING

ALLUMINIO 1050
ALUMINUM 1050

PER UNA PERFETTA TRASMISSIONE DEL CALORE
FOR PERFECT HEAT DISTRIBUTION

ACCIAIO FERRITICO
FERRITIC STEEL

PER L'INDUZIONE
FOR INDUCTION COOKING

RAME
COPPER

PER UNA FASCINO SENZA EGUALI
FOR AN UNPARALLELED CHARM

L'INTERNO IN ACCIAIO 18/10 RENDE IL COPPER 4 ADATTO AL SERVIZIO IN TAVOLA.

THE 18/10 STAINLESS STEEL INTERIOR MAKES THE COPPER 4 SUITABLE FOR TABLE SERVICE.

Manicatura in acciaio inox
Stainless steel handles



2,5 mm

Spessore totale
Total thickness 2,5 mm

P_s

Peso specifico
Specific weight

7.8 Acciaio inox 18/10
18/10 stainless steel

2.7 Alluminio 1050
Aluminum 1050

7.8 Acciaio ferritico
Ferritic steel

8.9 Rame
Copper



W/m²K

189

Capacità di condurre il calore
Heat conductivity



.....

Durata
Durability



NO lavastoviglie
NO Dishwasher



RONDEAU
CON DUE MANIGLIE

RONDEAU
WITH TWO STAINLESS STEEL HANDLES

Code	Ø cm	H cm	IVA esc.
COTE112CIT28	28	7,5	229,98 €
COTE112CIT32	32	8	273,62 €



**CASSERUOLA ALTA
CON UN MANICO E DUE BECCUCCI**

SAUCEPAN
WITH ONE HANDLE AND TWO SPOUTS



Code	Ø cm	H cm	lt	IVA esc.
COTE105CIT12	12	6,3	0,7	84,48 €
COTE105CIT14	14	7,3	1,1	100,42 €

Q U A T T R O



**CASSERUOLA ALTA
CON UN MANICO**

SAUCEPAN
WITH ONE HANDLE



Code	Ø cm	H cm	lt	IVA esc.
COTE105CIT16	16	9,2	1,8	122,71 €

F O U R



**CASSERUOLA BASSA
CON UN MANICO**

CASSEROLE PAN
WITH ONE HANDLE



Code	Ø cm	H cm	lt	IVA esc.
COTE107CIT20	20	8,4	2,6	130,57 €



PADELLA CON UN MANICO

FRYING PAN WITH ONE HANDLE



Code	Ø cm	H cm	IVA esc.
COTE111CIT20	20	4.3	100.80 €
COTE111CIT24	24	4.8	123.45 €
COTE111CIT28	28	5.3	147.87 €
COTE111CIT32	32	5.7	171.11 €

Eleganza SENZA TEMPO

IL RAME VIENE ABRASO PER FAR EMERGERE L'ACCIAIO FERRITICO, SENZA DISLIVELLI: ESTETICA PERFETTA E MASSIME PRESTAZIONI SU INDUZIONE.

THE COPPER IS ABRASD TO REVEAL THE FERRITIC STEEL, WITHOUT ANY UNEVENNESS: PERFECT AESTHETICS AND MAXIMUM PERFORMANCE ON INDUCTION.

Timeless ELEGANCE



COPERCHIO IN VETRO CON POMELLO IN ACCIAIO

GLASS LID WITH STEEL KNOB

Code	Ø cm	IVA esc.
ALCX129VE16	16	27.71 €
ALCX129VE20	20	28.31 €
ALCX129VE24	24	28.95 €
ALCX129VE28	28	29.96 €
ALCX129VE32	32	31.83 €

Agnelli
SINCE 1907

NEW

RAME
COPPER

FINITURA
LISCIA
FINISH
SMOOTH

COPPER



per tutti i piani di cottura
for all hobs

RAME



NEW

CASSERUOLA ALTA
CON DUE MANIGLIE

SAUCEPOT, 2 HANDLES
INDUCTION BOTTOM

Code	Ø cm	Ø disco ind. cm	H cm	lt	IVA esc.
ALCU0104PI20	20	14,5	12,4	3,3	300,27 €
ALCU0104PI24	24	18	18	5,6	382,39 €
ALCU0104PI28	28	22	16	9	445,47 €

Maniglie e manici in acciaio
inossidabile rivestito in PVD ottone
PVD coated stainless steel handles
and brass handles

Rivetti in acciaio
Steel rivets

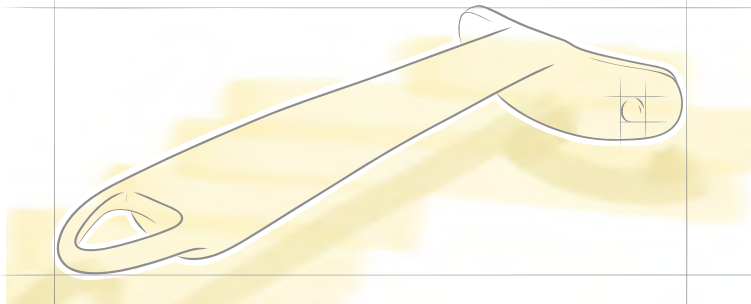



NEW

CASSERUOLA BASSA CON DUE MANIGLIE

CASSEROLE POT, 2 HANDLES
INDUCTION BOTTOM

Code	Ø cm	Ø disco ind. cm	H cm	lt	IVA esc.
ALCU0106PI20	20	14,5	7,9	2,5	275,04 €
ALCU0106PI24	24	18	9,4	4,1	323,16 €
ALCU0106PI28	28	22	10,5	6	386,46 €



NO lavastoviglie
NO Dishwasher



1,2mm

Spessore disco induzione
Induction disc thickness

Acciaio ferritico per induzione
Ferritic steel for induction



2 mm

Spessore totale
Total thickness 2 mm

 W/m²K
396

Capacità di condurre il calore
Heat conductivity

P_s 8,9
Peso specifico
Specific weight

Interno in stagnato a mano
Hand-tinned interior



NEW

CASSERUOLA ALTA CON UN MANICO

SAUCEPAN, 1 HANDLE, INDUCTION BOTTOM



Code	Ø cm	Ø disco ind. cm	H cm	lt	IVA esc.
ALCU0105PI20	20	14,5	12,4	3,3	280,33 €
ALCU0105PI24	24	18	18	5,6	360,86 €
ALCU0105PI28	28	22	16	9	422,47 €



NEW

CASSERUOLA BASSA
CON UN MANICO

CASSEROLE PAN, 1 HANDLE
INDUCTION BOTTOM



Code	Ø cm	Ø disco ind. cm	H cm	lt	IVA esc.
ALCU0107PI20	20	14,5	7,9	2,5	255,09 €
ALCU0107PI24	24	18	9,4	4,1	301,69 €
ALCU0107PI28	28	22	10,5	6	363,40 €



NEW

TEGAME
CON DUE MANIGLIE

OMELETTE PAN, 2 HANDLES



Code	Ø cm	Ø disco ind. cm	H cm	IVA esc.
ALCU0110PI20	20	14,5	5,7	237,23 €
ALCU0110PI24	24	18	6,4	281,55 €
ALCU0110PI28	28	22	7,3	319,60 €



NEW

PADELLA CON UN MANICO

FRYPAN, 1 HANDLE, INDUCTION BOTTOM



Code	Ø cm	Ø disco ind. cm	H cm	IVA esc.
ALCU0111PI20	20	14,5	5,7	216,63 €
ALCU0111PI24	24	18	6,4	260,23 €
ALCU0111PI28	28	22	7,3	296,55 €

FINITURA MARTELLATA
HAMMERED FINISH



PAIOLO IN RAME PER POLENTA
"SENZA STAGNATURA"
SPESORE 1,2MM RAME

COPPER POLENTA POT, "WITHOUT TINNING"

Code	Ø cm	Ø disco ind. cm	H cm	lt	IVA esc.
ALCM165MPI24	24	14	13	2,9	284,43 €
ALCM165MPI26	26	16	13,5	3,9	313,20 €
ALCM165MPI28	28	17,5	14	4,9	363,55 €
ALCM165MPI30	30	19,5	15	5,9	392,32 €

Agnelli
SINCE 1907

COPPER

RAME
COPPER

FINITURA
LISCIA
FINISH
SMOOTH



No induzione
No induction

RAME

NEW

CASSERUOLA ALTA
CON DUE MANIGLIE

SAUCEPOT, 2 HANDLES



Code	Ø cm	H cm	lt	IVA esc.
ALCU010420	20	11	3,3	210,27 €
ALCU010424	24	14	5,6	280,64 €
ALCU010428	28	16	9	342,91 €
ALCU010432	32	18	12,5	428,78 €
ALCU010436	36	19,6	18	492,53 €
ALCU010440	40	22	26	606,69 €

NEW

CASSERUOLA BASSA
CON DUE MANIGLIE

CASSEROLE POT, 2 HANDLES



Code	Ø cm	H cm	lt	IVA esc.
ALCU010620	20	7	2,5	190,54 €
ALCU010624	24	8	4,1	229,55 €
ALCU010628	28	9	6	289,07 €
ALCU010632	32	10	8	335,93 €
ALCU010636	36	11,5	12	376,23 €
ALCU010640	40	14	16	488,25 €
ALCU010645	45	16,5	23	647,75 €

W/m²K**396**Capacità di
condurre il calore

Heat conductivity

Maniglie e manici in acciaio
inossidabile rivestito in PVD
ottonePVD coated stainless steel
handles and brass handles**P_s** 8,9 kg

Peso specifico

Specific weight

Rivetti in acciaio
Steel rivetsDurata
Durability

2 mm

Spessore totale
Total
thickness 2 mmInterno in stagnato a mano
Hand-tinned interiorNO lavastoviglie
NO Dishwasher**NEW****CASSERUOLA ALTA
CON UN MANICO**

SAUCEPAN, 1 HANDLE



Code	Ø cm	H cm	lt	IVA esc.
ALCU010516	16	8	1,7	153,04 €
ALCU010520	20	11	3,3	190,33 €
ALCU010524	24	14	5,6	259,26 €
ALCU010528	28	16	9	318,84 €

RAME STAGNATO FINITURA LISCIA

AGNELLI SINCE 1907

NEW

CASSERUOLA BASSA CON UN MANICO

CASSEROLE PAN, 1 HANDLE



Code	Ø cm	H cm	lt	IVA esc.
ALCU010720	20	7	2,5	170,54 €
ALCU010724	24	8	4,1	242,68 €

NEW

TEGAME CON DUE MANIGLIE

OMELETTE PAN, 2 HANDLES



Code	Ø cm	H cm	IVA esc.
ALCU011020	20	5	167,79 €
ALCU011024	24	5,8	193,74 €
ALCU011028	28	5	227,52 €
ALCU011032	32	6,3	268,37 €
ALCU011036	36	7	305,82 €
ALCU011040	40	7,5	388,69 €
ALCU011045	45	8,5	514,14 €
ALCU011050	50	8,5	606,64 €
ALCU011060	60	10	800,22 €

NEW

COPERCHIO PIANO CON PONTICELLO

FLAT LID



Code	cm	IVA esc.
ALCU012916	16	45,89 €
ALCU012918	18	49,54 €
ALCU012920	20	53,72 €
ALCU012922	22	62,34 €
ALCU012924	24	80,83 €
ALCU012928	28	99,13 €
ALCU012932	32	117,31 €
ALCU012936	36	137,64 €
ALCU012940	40	140,14 €
ALCU012945	45	190,93 €
ALCU012950	50	238,37 €
ALCU012960	60	389,32 €

NEW

**PADELLA SVASATA ALTA
"SALTAPASTA" CON UN MANICO**

SAUTÈ PAN "PASTA" WITH ONE HANDLE



Code	Ø cm	H cm	IVA esc.
ALCU0111B20	20	5.3	144.29 €
ALCU0111B24	24	6	175.77 €
ALCU0111B28	28	7	196.02 €
ALCU0111B32	32	7.8	232.56 €
ALCU0111B36	36	8	285.06 €

PADELLA SVASATA ALTA "SALTAPASTA"
SAUTÈ PAN "PASTA"

PROFILO SLANCIATO, IDEALE PER SALTARE E
MESCOLARE CON AGILITÀ.



SLENDER PROFILE, IDEAL FOR TOSSING AND
STIRRING WITH EASE.

SVASATA BASSA
LOW FLARED

FONDO AMPIO E STABILE,
GARANTISCE MAGGIORE SPAZIO DI LAVORO



WIDE AND STABLE BASE,
PROVIDES MORE WORKING SPACE.

NEW

**PADELLA SVASATA BASSA
CON UN MANICO**

LOW SAUTÉ PAN, 1 HANDLE



Code	Ø cm	H cm	IVA esc.
ALCU0111BB20	20	5	144.24 €
ALCU0111BB24	24	5.8	175.77 €
ALCU0111BB28	28	5	204.47 €
ALCU0111BB32	32	6.3	244.71 €
ALCU0111BB36	36	7	301.90 €

RAME STAGNATO
FINITURA LISCIA

AGNELLI SINCE 1907

RAME



**CASSERUOLA ALTA
CON UN MANICO IN OTTONE FUSO**

SAUCEPAN, 1 CAST IRON HANDLE

Code	Ø cm	H cm	lt	IVA esc.
ALCU105G20	20	11	3,3	313,16 €
ALCU105G24	24	14	5,6	373,49 €

**MANICO ALLA FRANCESE
IN OTTONE FUSO**

**FRENCH HANDLE
IN CAST BRASS**

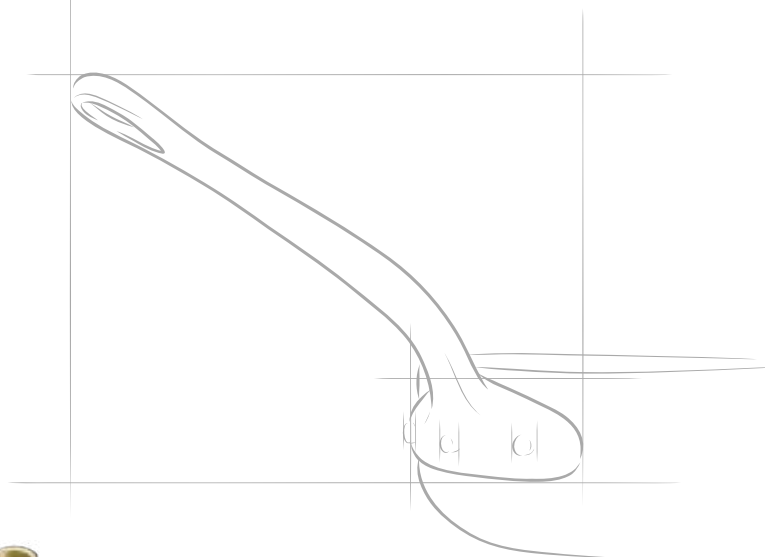

**CASSERUOLA BASSA
CON UN MANICO IN OTTONE FUSO**

CASSEROLE PAN, 1 CAST IRON HANDLE

Code	Ø cm	H cm	lt	IVA esc.
ALCU107G20	20	7	2,5	305,24 €
ALCU107G24	24	8	4,1	339,62 €



PAIOLO IN RAME PER POLENTA
"SENZA STAGNATURA"
CON UN MANICO E MANIGLIA OTTONE

COPPER POLENTA POT, "WITHOUT TINNING"

Code	Ø cm	H cm	lt	IVA esc.
ALCU16518	18	12	2	134,11 €
ALCU16520	20	13	3	138,15 €
ALCU16522	22	14	3,5	148,93 €
ALCU16524	24	14	4,5	162,12 €
ALCU16526	26	17	6	178,82 €



CASSERUOLA OVALE ALTA
CON DUE MANIGLIE OTTONE E COPERCHIO

OVAL SAUCEPOT WITH LID

Code	cm	H cm	lt	IVA esc.
ALCU12630	30x22	12	6,22	387,21 €



CASSERUOLA BASSA BOMBATA
CON DUE MANIGLIE OTTONE E COPERCHIO

CURVED SAUCEPOT 2 HANDLES WITH LID

Code	Ø cm	H cm	lt	IVA esc.
ALCU108C24	24	9,5	5,5	368,03 €
ALCU108C28	28	10,5	7,1	537,37 €



PESCIERA CON COPERCHIO, GRIGLIA E
DUE MANIGLIE OTTONE

FISH-KETTLE WITH GRID AND LID

Code	cm	H cm	IVA esc.
ALCU11840	40x17	10	516,30 €



ROSTIERA CON COPERCHIO E
DUE MANIGLIE SNODATE OTTONE

RECTANGULAR PAN WITH LID

Code	est. cm	int. cm	H cm	IVA esc.
ALCU150C32	34,3x23,7	32x23	6	391,05 €
ALCU150C36	39,5x26,5	36x26	6	473,83 €

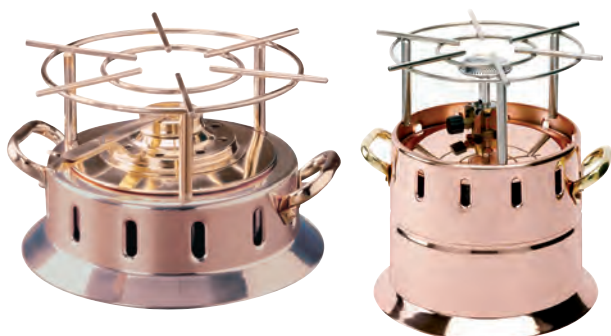

FLAMBEAU RAME DA SALA
(SENZA PADELLA)

COPPER SERVING FLAMBEAU (WITHOUT PAN)

Code	IVA esc.
COCUFLAMALCOOL	398,85 €
COCUFLAMGAS	462,15 €

Bombola camping a 2 gaz R904 da 1,8 kg o R901 da 0,4 kg

NON INCLUDE

Camping gaz R904 or R901 NOT INCLUDED

PADELLA LEGGERA IN RAME STAGNATO
PER FLAMBEAU
CON UN MANICO IN LEGNO

TINNED COPPER LIGHT FRYPAN
FOR FLAMBEAU, WOODEN HANDLE



Code	Ø cm	H cm	IVA esc.
COCUPADFLAM26	26	4,5	138,17 €
COCUPADFLAM28	28	4,5	160,36 €



**POLSONETTO RAME STAGNATO
PER BAGNOMARIA,
NON STAGNATO PER PASTICCERIA**

COPPER POLSONETTO, TINNED FOR BAINE-MARIE
NOT TINNED FOR PASTRY

Code	Ø cm	IVA esc.
COCU294NS18	18	130,45 €
COCU294S18	18	138,83 €



**OLIERA RAME CON COPERCHIO
CON ORLO SALVA GOCCIA**

OIL POURER WITH LID AND DRIP SAVER EDGE

Code	lt	IVA esc.
COCU36020,5	0,5	112,35 €
COCU36021	1	128,40 €



PAIOLO ELETTRICO CON MESCOLATORE
E SUPPORTO IN FERRO, MOTORE 30W,
PORZIONI 30/34

POLENTA AND RISOTTO MIXER WITH LARGE POT

Code	Ø cm	H con base cm	lt	IVA esc.
COCU3165K9	34	22.2	12	510,00 €



PAIOLO ELETTRICO CON MESCOLATORE E
SUPPORTO IN FERRO, MOTORE 16W/
PORZIONI 10/12

POLENTA AND RISOTTO MIXER WITH LARGE POT

Code	Ø cm	H con base cm	lt	IVA esc.
COCU3165K4.5	26	14.8	4.5	225,75 €

Agnelli
SINCE 1907

NEW

RAME
COPPER

FINITURA
MARTELLATA
HAMMERED
FINISH

COPPER



No induzione
No induction

RAME



NEW

CASSERUOLA ALTA
CON DUE MANIGLIE

SAUCEPOT, 2 HANDLES

Code	Ø cm	H cm	lt	IVA esc.
ALCM0104M20	20	11	3.3	235.05 €
ALCM0104M24	24	12	4.5	305.41 €
ALCM0104M28	28	16	9	420.34 €



NEW

CASSERUOLA BASSA
CON DUE MANIGLIE

CASSEROLE POT, 2 HANDLES

Code	Ø cm	H cm	lt	IVA esc.
ALCM0106M20	20	7	2.5	213.73 €
ALCM0106M24	24	8	4.1	252.81 €
ALCM0106M28	28	9	6.4	312.27 €
ALCM0106M32	32	10	8	340.31 €
ALCM0106M36	36	11.5	12	500.21 €



396 W/m²K
 Capacità di condurre il calore
 Heat conductivity



2 mm
 Spessore totale
 Total thickness 2 mm

P_s 8,9

Peso specifico
 Specific weight

Interno in stagnato a mano
 Hand-tinned interior

Finitura martellata
 Hammered finish



NO lavastoviglie
 NO Dishwasher

Maniglie e manici in acciaio inossidabile rivestito in PVD
 ottone

PVD coated stainless steel handles and brass handles

NEW

**CASSERUOLA ALTA
 CON UN MANICO**

SAUCEPAN, 1 HANDLE



Code	Ø cm	H cm	lt	IVA esc.
ALCM0105M16	16	8	1,7	177,81 €
ALCM0105M20	20	11	3,3	215,11 €

NEW

CASSERUOLA BASSA
CON UN MANICO

CASSEROLE PAN, 1 HANDLE



Code	Ø cm	H cm	lt	IVA esc.
ALCM0107M20	20	7	2,5	193,79 €
ALCM0107M24	24	8	4,1	231,39 €

NEW

TEGAME CON DUE MANIGLIE

OMELETTE PAN, 2 HANDLES



Code	Ø cm	H cm	IVA esc.
ALCM0110M20	20	5	173,89 €
ALCM0110M24	24	5,5	199,90 €
ALCM0110M28	28	6	249,14 €
ALCM0110M32	32	6,5	296,20 €
ALCM0110M36	36	7	342,95 €
ALCM0110M40	40	7,5	419,62 €

NEW

COPERCHIO PIANO 1,2 MM
CON PONTICELLO

FLAT LID



Code	Ø cm	IVA esc.
ALCM0129M16	16	60,82 €
ALCM0129M20	20	72,85 €
ALCM0129M24	24	103,15 €
ALCM0129M28	28	127,97 €
ALCM0129M32	32	158,69 €
ALCM0129M36	36	185,29 €
ALCM0129M40	40	192,13 €

NEW

PADELLA SVASATA ALTA
"SALTAPASTA" CON UN MANICO

SAUTÈ PAN "PASTA" WITH ONE HANDLE



Code	Ø cm	H cm	IVA esc.
ALCM0111BM20	20	5	153,91 €
ALCM0111BM24	24	6	185,04 €
ALCM0111BM28	28	6,5	220,85 €
ALCM0111BM32	32	7	263,28 €
ALCM0111BM36	36	7,5	321,07 €

PADELLA SVASATA ALTA "SALTAPASTA"
SAUTÈ PAN "PASTA"

PROFILO SLANCIATO, IDEALE PER SALTARE E
MESCOLARE CON AGILITÀ.



SLENDER PROFILE, IDEAL FOR TOSSING AND
STIRRING WITH EASE.

SVASATA BASSA
LOW FLARED

FONDO AMPIO E STABILE,
GARANTISCE MAGGIORE SPAZIO DI LAVORO

WIDE AND STABLE BASE,
PROVIDES MORE WORKING SPACE.



NEW

PADELLA SVASATA BASSA
CON UN MANICO

LOW SAUTÉ PAN, 1 HANDLE



Code	Ø cm	H cm	IVA esc.
ALCM0111BBM20	20	5	153,95 €
ALCM0111BBM24	24	5,5	178,58 €
ALCM0111BBM28	28	6	225,99 €
ALCM0111BBM32	32	6,5	272,60 €
ALCM0111BBM36	36	7	367,68 €



**TEGAME OVALE
CON DUE MANIGLIE E COPERCHIO**

OVAL OMELETTE PAN WITH LID

Code	cm	H cm	IVA esc.
ALCM120M30	30x22	6,5	€ 268,52



**PESCIERA CON COPERCHIO, GRIGLIA
E DUE MANIGLIE**

FISH-KETTLE WITH GRID AND LID

Code	cm	H cm	IVA esc.
ALCM118M40	40x17	10	545,45 €



**ROSTIERA
CON DUE MANIGLIE SNODATE E
COPERCHIO**

ROASTING PAN WITH LID

Code	est. cm	int. cm	H cm	IVA esc.
ALCM150M32	35x23,2	32x23	6	455,37 €
ALCM150M36	39,5x26,5	36x26	6	510,83 €



**CASSERUOLA OVALE
CON DUE MANIGLIE E COPERCHIO**

OVAL SAUCEPOT WITH LID

Code	cm	H cm	lt	IVA esc.
ALCM126M30	30x22	12	6,22	436,65 €



**CASSERUOLA BASSA BOMBATA
CON DUE MANIGLIE E COPERCHIO**

CURVED CASSEROLE POT 2 HANDLES WITH LID

Code	Ø cm	H cm	lt	IVA esc.
ALCM108MC24	24	9,5	5,5	382,88 €
ALCM108MC28	28	10,5	7,1	584,18 €



**TORTIERA PER FARINATA
MARTELLATA CON ORLO**

MOULD FOR FARINATA, HAMMERED, WITH RIM

Code	Ø cm	H cm	IVA esc.
COCU43/330	30	1	73,40 €
COCU43/332	32	1	85,87 €
COCU43/334	34	1	97,84 €
COCU43/336	36	1	108,32 €
COCU43/338	38	1	118,00 €
COCU43/340	40	1,2	141,31 €
COCU43/342	42	1,2	150,31 €
COCU43/345	45	1,2	163,93 €
COCU43/350	50	1,5	227,12 €
COCU43/360	60	1,5	418,49 €



**CASSERUOLA ALTA
CON UN MANICO FUSO**

SAUCEPAN WITH BRASS HANDLE

Code	Ø cm	H cm	lt	IVA esc.
ALCU105F10	10	6,5	0,51	114,24 €
ALCU105F12	12	7,5	0,85	130,22 €
ALCU105F14	14	8	1,31	141,56 €
ALCU105F16	16	8,5	1,61	133,02 €
ALCU105F18	18	10	2,54	140,65 €
ALCU105F20	20	11	3,46	159,32 €
ALCU105F22	22	11,2	4,26	184,32 €
ALCU105F24	24	14	6,33	205,87 €



**CASSERUOLA BASSA
CON UN MANICO OTTONE FUSO**

CASSEROLE PAN WITH BRASS HANDLE

Code	Ø cm	H cm	lt	IVA esc.
ALCU107F10	10	4	0,31	105,67 €
ALCU107F12	12	4,5	0,51	121,74 €
ALCU107F14	14	5,5	0,85	133,08 €
ALCU107F16	16	6,8	1,37	126,66 €
ALCU107F18	18	7	1,78	132,33 €
ALCU107F20	20	8	2,51	144,32 €
ALCU107F22	22	9	3,42	165,29 €
ALCU107F24	24	10	4,52	216,67 €



**PAIOLO
CON MANICO ARCO IN FERRO ZINCATO**

POLENTA POT, BOWED HANDLE

Code	Ø cm	H cm	lt	IVA esc.
COCM44M24	24	13,5	4,2	113,78 €
COCM44M28	28	16	6,25	161,04 €
COCM44M32	32	17	9	202,22 €



**PAIOLO
CON UN MANICO IN LEGNO
E MANIGLIA INOX**

POLENTA POT, WOODEN HANDLE

Code	Ø cm	H cm	lt	IVA esc.
COCM65M18	18	10	1,85	96,12 €
COCM65M20	20	11,5	2,5	96,69 €
COCM65M22	22	13,5	3,35	108,57 €
COCM65M24	24	13,5	4,2	125,73 €
COCM65M26	26	14,3	4,6	157,83 €



per tutti i piani di cottura
for all hobs



 **SPESORE 5MM** 5MM THICKNESS

**CASSERUOLA ALTA
CON DUE MANIGLIE**

**SAUCEPOT
WITH TWO STAINLESS STEEL HANDLES**

Code	Ø cm	Ø disco ind. cm	H cm	lt	IVA esc.
ALCX1104PI20	20	14,5	12	3,3	104,69 €
ALCX1104PI24	24	18	13,5	5,6	123,56 €
ALCX1104PI28	28	22	16	9	151,34 €



1,2mm

Spessore disco induzione

Induction disc thickness

Acciaio ferritico per induzione

Ferritic steel for induction

Rivetti in acciaio inox

Stainless steel rivets

P_s 2.7
Peso specifico
Specific weight

 W/m²K

295

Capacità di
condurre il calore
Heat conductivity

Manicatura e rivetti in
acciaio inox
Stainless steel handle
and rivets



No lavastoviglie
No Dishwasher



per tutti i piani di cottura
for all hobs

 **SPESORE 5MM** 5MM THICKNESS

**CASSERUOLA BASSA
CON DUE MANIGLIE**

**CASSEROLE POT
WITH TWO STAINLESS STEEL HANDLES**

Code	Ø cm	Ø disco ind. cm	H cm	lt	IVA esc.
ALCX1106Pl24	24	18	9	4.1	107.24 €
ALCX1106Pl28	28	22	9.5	6.4	130.23 €
ALCX1106Pl32	32	24.5	10.5	7.4	149.11 €



ALLUMINIO
3/5 MM INDUZIONE

AGNELLI SINCE 1907



SPESORE 5MM 5MM THICKNESS

CASSERUOLA BASSA
CON UN MANICO

CASSEROLE PAN
WITH ONE HANDLE



Code	Ø cm	Ø disco ind. cm	H cm	lt	IVA esc.
ALCX1107PI20	20	14.5	7	2.5	76.03 €
ALCX1107PI24	24	18	9	4.1	93.24 €



SPESORE 3MM 3MM THICKNESS

PADELLA SVASATA ALTA
"SALTAPASTA" CON UN MANICO

SAUTÈ PAN "PASTA" WITH ONE HANDLE



Code	Ø cm	Ø disco ind. cm	H cm	IVA esc.
ALCX111BPI24	24	12.5	6.5	61.17 €
ALCX111BPI28	28	15	7.2	69.15 €
ALCX111BPI32	32	18.5	7.5	83.20 €



COPERCHIO IN VETRO CON
POMELLO IN ACCIAIO

GLASS LID WITH STEEL KNOB

Code	Ø cm	IVA esc.
ALCX129VE16	16	27.71 €
ALCX129VE20	20	28.31 €
ALCX129VE24	24	28.95 €
ALCX129VE28	28	29.96 €
ALCX129VE32	32	31.83 €

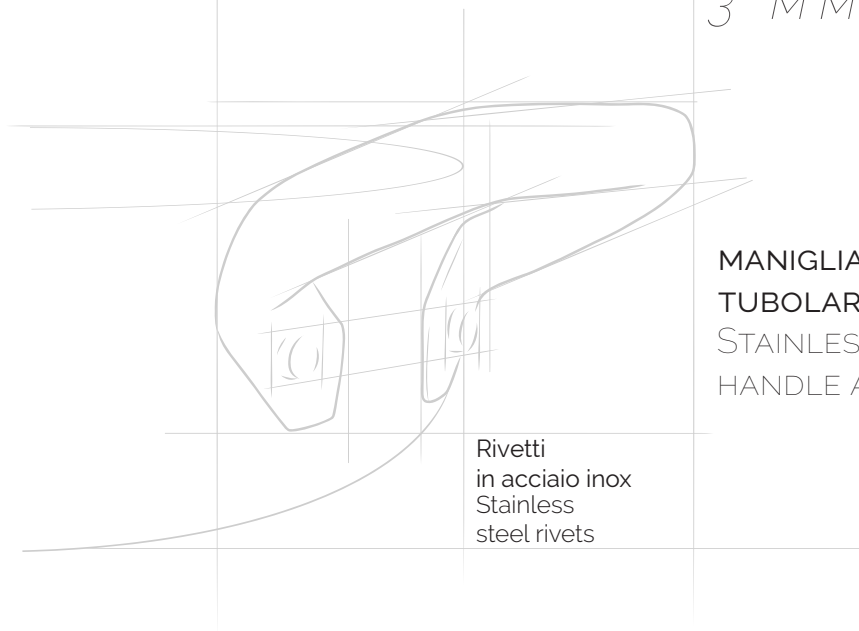

**MANIGLIA E MANICI
TUBOLARI IN ACCIAIO INOX**
STAINLESS STEEL TUBULAR
HANDLE AND HANDLES

Rivetti
in acciaio inox
Stainless
steel rivets

 **SPESORE 3MM** 3MM THICKNESS

**CASSERUOLA ALTA
CON DUE MANIGLIE INOX**

SAUCEPOT
WITH TWO STAINLESS STEEL HANDLES



Code	Ø cm	Ø disco ind. cm	H cm	lt	IVA esc.
ALMA104PI20	20	14,5	11,5	3,3	56,78 €
ALMA104PI24	24	18	14	5,6	69,14 €
ALMA104PI28	28	22	16	9	81,43 €
ALMA104PI32	32	24,5	17	12,5	98,19 €

 **SPESORE 3MM** 3MM THICKNESS

**CASSERUOLA BASSA
CON DUE MANIGLIE INOX**

CASSEROLE POT
WITH TWO STAINLESS STEEL HANDLES



Code	Ø cm	Ø disco ind. cm	H cm	lt	IVA esc.
ALMA106PI20	20	14,5	7	2,5	53,36 €
ALMA106PI24	24	18	9	4,1	63,94 €
ALMA106PI28	28	22	9,5	6,4	75,26 €
ALMA106PI32	32	24,5	10,5	7,4	90,35 €



 **SPESORE 3MM** 3MM THICKNESS

CASSERUOLA ALTA CON UN MANICO INOX "COOL"

SAUCEPAN, "COOL" S/S TUBULAR HANDLE

Code	Ø cm	Ø disco ind. cm	H cm	lt	IVA esc.
ALMC105PIC16	16	13	8	1.5	47.30 €
ALMC105PIC20	20	14.5	11.5	3.3	55.79 €
ALMC105PIC24	24	18	14	5.6	66.11 €
ALMC105PIC28	28	22	16	9	79.58 €



 **SPESORE 3MM** 3MM THICKNESS

CASSERUOLA BASSA CON UN MANICO INOX "COOL"

CASSEROLE PAN, 1 "COOL" S/S HANDLE

Code	Ø cm	Ø disco ind. cm	H cm	lt	IVA esc.
ALMC107PIC20	20	14.5	7	2.5	52.36 €
ALMC107PIC24	24	18	9	4.1	60.94 €
ALMC107PIC28	28	22	9.5	6.4	72.67 €



 **SPESORE 3MM** 3MM THICKNESS

TEGAME CON DUE MANIGLIE INOX

OMELETTE PAN, 2 S/S HANDLES

Code	Ø cm	Ø disco ind. cm	H cm	IVA esc.
ALMA110PI20	20	14.5	5.5	50.60 €
ALMA110PI24	24	18	6.0	59.36 €
ALMA110PI28	28	22	6.5	73.37 €
ALMA110PI32	32	24.5	7	84.32 €



 **SPESORE 3MM** 3MM THICKNESS

**PADELLA SVASATA ALTA
"SALTAPASTA" CON UN MANICO "COOL"**

SAUTÈ PAN "PASTA" WITH "COOL" HANDLE

Code	Ø cm	Ø disco ind. cm	H cm	IVA esc.
ALMC111BPIC24	24	12,52	4,5	48,72 €
ALMC111BPIC28	28	15	4,5	55,48 €
ALMC111BPIC32	32	18,5	5	64,71 €
ALMC111BPIC36	36	22,5	6,5	75,29 €



 **SPESORE 5MM** 5MM THICKNESS

**PAIOLO PER POLENTA CON MANICO INOX E
CONTROMANIGLIA**

RADIANT POLENTA POT WITH S/S HANDLE
AND INDUCTION BOTTOM

Code	Ø cm	Ø disco ind. cm	H cm	lt	IVA esc.
ALMR1165PI24	24	12	12	4,5	70,54 €



**COPERCHIO ROTONDO PESANTE
CON PONTICELLO INOX**

ROUND HEAVY LID WITH SMALL S/S LOOP
HANDLE. PACK 10 PCS.

Code	Ø cm	IVA esc.
ALMA12920	20	10,85 €
ALMA12924	24	12,27 €
ALMA12928	28	15,24 €
ALMA12932	32	19,03 €
ALMA12936	36	23,04 €



**PENTOLA RADIANTE
CON DUE MANIGLIE INOX**

RADIANT STOCKPOT,
2 S/S HANDLES

Code	Ø cm	H cm	lt	IVA esc.
ALMR110320	20	19	6	72,43 €
ALMR110324	24	22	10	84,92 €
ALMR110328	28	26	16	112,91 €
ALMR110332	32	30	24	144,24 €
ALMR110336	36	33	33	171,02 €
ALMR110340	40	38	45	206,03 €
ALMR110345	45	40	65	250,75 €
ALMR110350	50	45	85	282,55 €

**CASSERUOLA ALTA RADIANTE
CON DUE MANIGLIE INOX**

RADIANT SAUCEPOT,
2 S/S HANDLES



Code	Ø cm	H cm	lt	IVA esc.
ALMR110416	16	11	2,0	41,26 €
ALMR110420	20	11	3,3	50,76 €
ALMR110424	24	14	5,6	65,37 €
ALMR110428	28	16	9	78,57 €
ALMR110432	32	18	12,5	108,15 €
ALMR110436	36	19,5	18	128,67 €
ALMR110440	40	22	26	155,32 €
ALMR110445	45	25	35	188,76 €
ALMR110450	50	28	50	223,60 €
ALMR110455	55	31	65	340,35 €
ALMR110460	60	35	90	448,79 €

CASSERUOLA BASSA RADIANTE CON DUE MANIGLIE INOX

RADIANT CASSEPOLE POT,
2 S/S HANDLES



Code	Ø cm	H cm	lt	IVA esc.
ALMR110620	20	7	2,5	38,60 €
ALMR110624	24	8	3,7	54,19 €
ALMR110628	28	9	5,6	64,71 €
ALMR110632	32	10	8	80,80 €
ALMR110636	36	12	12	109,16 €
ALMR110640	40	13	16	130,33 €
ALMR110645	45	15	23	155,11 €
ALMR110650	50	17	32	180,74 €
ALMR110655	55	19	51,5	252,11 €
ALMR110660	60	21,5	60	310,16 €

Manicatura
in acciaio inox
Stainless steel
handles

Rivetti in alluminio
Aluminum rivets

P_s 2,7
Peso specifico
Specific weight

 W/m²K

295

Capacità di
condurre il calore
Heat conductivity

 Spessore totale
5 mm Total thickness 5 mm

   No induzione
No induction

 No lavastoviglie
No Dishwasher



CASSERUOLA ALTA RADIANTE CON MANICO INOX

RADIANT SAUCEPAN,
1 S/S HANDLE

Code	Ø cm	H cm	lt	IVA esc.
ALMR110516	16	11	2,0	41,26 €
ALMR110518	18	10	2,6	43,03 €
ALMR110520	20	11	3,3	50,76 €



CASSERUOLA BASSA RADIANTE CON
MANICO INOX

RADIANT CASSEPOLE PAN,
1 S/S HANDLE

Code	Ø cm	H cm	lt	IVA esc.
ALMR110720	20	7	2,5	38,60 €
ALMR110724	24	8	3,7	54,19 €
ALMR110728	28	9	5,6	64,15 €



TEGAME RADIANTE
CON DUE MANIGLIE INOX

RADIANT OMELETTE PAN, 2 S/S HANDLES

Code	Ø cm	H cm	IVA esc.
ALMR111020	20	5,5	27,11 €
ALMR111024	24	6	34,66 €
ALMR111028	28	6,5	42,79 €
ALMR111032	32	7	52,09 €
ALMR111036	36	7	63,46 €
ALMR111040	40	7,5	74,13 €
ALMR111045	45	8	105,55 €
ALMR111050	50	8,5	133,09 €

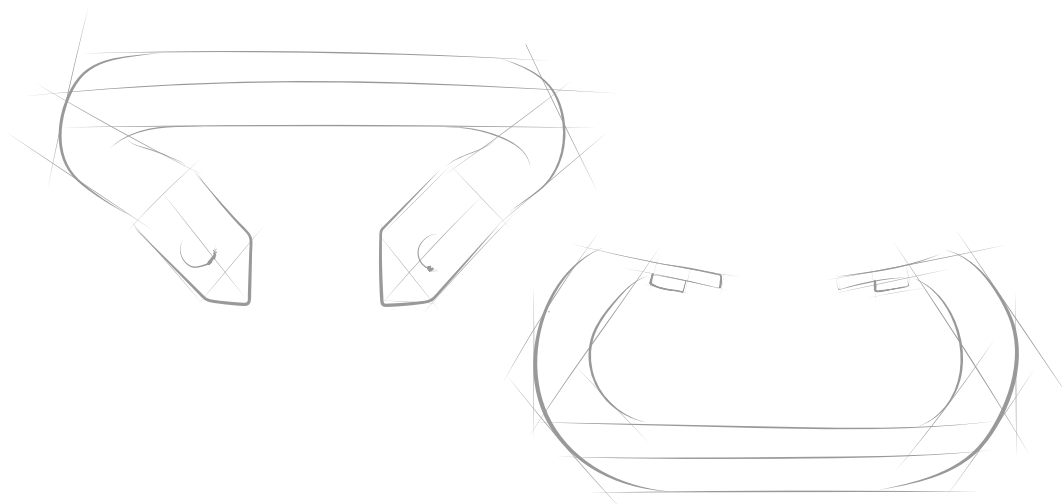



PADELLA SVASATA ALTA
"SALTAPASTA" CON UN MANICO

SAUTÈ PAN "PASTA" WITH ONE HANDLE

Code	Ø cm	H cm	IVA esc.
ALMR1111B20	20	5,5	27,29 €
ALMR1111B24	24	7	34,97 €
ALMR1111B28	28	7	42,61 €
ALMR1111B32	32	7,5	52,10 €
ALMR1111B36	36	8	64,76 €
ALMR1111B40	40	8,5	74,71 €

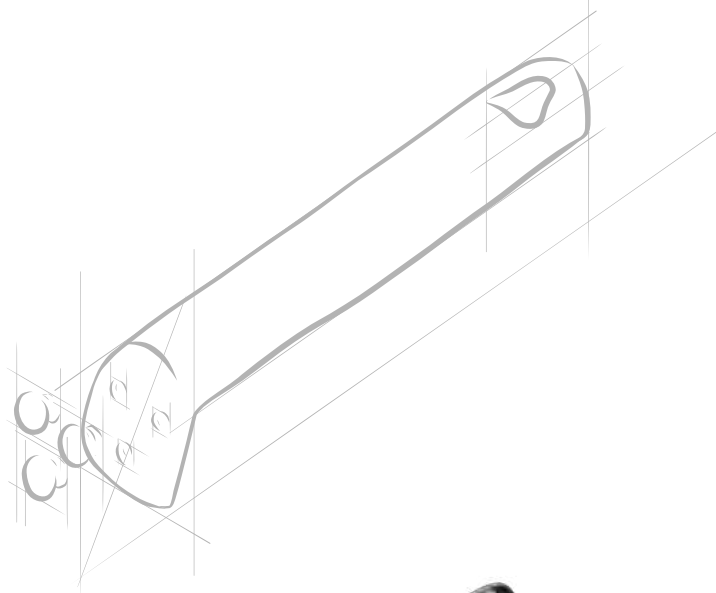

PADELLA SVASATA ALTA
"SALTAPASTA" CON UN MANICO "COOL"

SAUTÈ PAN "PASTA" WITH "COOL" HANDLE

Code	Ø cm	H cm	IVA esc.
ALMC1111BC20	20	5,5	29,51 €
ALMC1111BC24	24	7	37,39 €
ALMC1111BC28	28	7	45,56 €
ALMC1111BC32	32	7,5	55,51 €
ALMC1111BC36	36	8	68,66 €
ALMC1111BC40	40	8,5	79,08 €



PADELLA RADIANTE CON MANICO INOX

RADIANT FRYPAN, 1 S/S HANDLE

Code	Ø cm	H cm	IVA esc.
ALMR111120	20	4.5	26.37 €
ALMR111124	24	4.5	33.73 €
ALMR111128	28	5	41.63 €
ALMR111132	32	6	50.67 €
ALMR111136	36	7	62.87 €
ALMR111140	40	7.5	71.93 €



PADELLA RADIANTE CON UN MANICO INOX "COOL"

STRAIGHT FRYING PAN, 5MM (3/16") THICK, "COOL" HANDLE

Code	Ø cm	H cm	IVA esc.
ALMC1111C20	20	4.5	29.70 €
ALMC1111C24	24	4.5	35.61 €
ALMC1111C28	28	5	43.80 €
ALMC1111C32	32	6	53.56 €
ALMC1111C36	36	7	65.91 €
ALMC1111C40	40	7.5	76.79 €



WOK RADIANTE CON FONDO PIANO CON MANICO INOX

RADIANT WOK WITH FLAT BOTTOM AND TUBULAR STAINLESS STEEL HANDLE

Code	Ø cm	H cm	IVA esc.
ALMR1111WP28	28	9.5	59.30 €
ALMR1111WP32	32	10	72.20 €



PADELLA RADIANTE "MANTECARE" SALTA PASTA E RISO CON MANICO INOX

RADIANT PAN "MANTECARE" PASTA AND RICE SAUTÉ WITH STAINLESS STEEL TUBULAR HANDLE

Code	Ø cm	H cm	IVA esc.
ALMR1111BM20	20	9	32,94 €
ALMR1111BM24	24	9,5	45,45 €
ALMR1111BM28	28	10	54,33 €
ALMR1111BM32	32	10,5	65,21 €
ALMR1111BM36	36	11	84,36 €

GRAZIE ALLA FORMA SVASATA, LA PADELLA A MANTECARE FAVORISCE LO SCAMBIO D'ARIA E L'USCITA DELL'UMIDITÀ.

ITS FLARED SHAPE ALLOWS AIR CIRCULATION AND MOISTURE RELEASE.

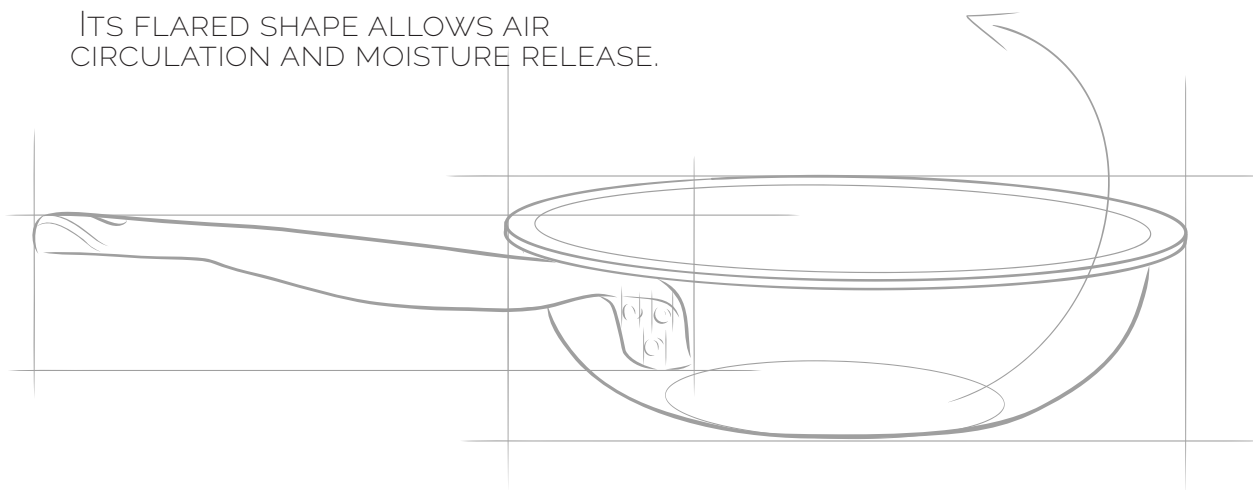

WOK RADIANTE CON FONDO SVASATO CON MANICO INOX

RADIANT WOK, SPLAYED BOTTOM

Code	Ø cm	H cm	IVA esc.
ALMR1111W28	28	10,5	59,30 €
ALMR1111W32	32	11	72,20 €



**PAIOLO RADIANTE PER POLENTA
CON MANICO E MANIGLIA INOX**

RADIANT POLENTA POT WITH S/S
HANDLE AND HAND GRIP

Code	Ø cm	H cm	lt	IVA esc.
ALMR65B18	18	12	2	34,36 €
ALMR65B20	20	13	3	38,78 €
ALMR65B22	22	14	3,5	48,61 €
ALMR65B24	24	12	4,5	53,03 €
ALMR65B26	26	13	6	59,62 €
ALMR65B28	28	14	7	66,03 €
ALMR65B30	30	14	8	76,85 €

**COPERCHIO ROTONDO PESANTE CON
PONTICELLO INOX**

ROUND HEAVY LID WITH SMALL S/S
LOOP HANDLE PACK 10 PCS



Code	Ø cm	IVA esc.
ALMA12914	14	5,32 €
ALMA12916	16	5,85 €
ALMA12918	18	6,45 €
ALMA12920	20	10,85 €
ALMA12922	22	11,68 €
ALMA12924	24	12,27 €
ALMA12926	26	13,04 €
ALMA12928	28	15,24 €
ALMA12930	30	17,16 €
ALMA12932	32	19,03 €
ALMA12934	34	21,69 €
ALMA12936	36	23,04 €
ALMA12938	38	24,49 €
ALMA12940	40	26,38 €
ALMA12945	45	39,70 €
ALMA12950	50	47,52 €
ALMA12955	55	64,75 €
ALMA12960	60	77,33 €



TEGAME GIUBILEO CON
QUATTRO MANIGLIE INOX
SPESSORE 5MM

OMELETTE PAN 4 HANDLES

Code	Ø cm	H cm	IVA esc.
ALPARTGIUBILEO	102	21	1.149,68 €

ROSTIERA RETTANGOLARE RADIANTE
CON MANIGLIE SNODATE

RADIANT RECTANGULAR ROASTING
PLATE WITH FOLDING HANDLES



Code	est. cm	int. cm	H cm	IVA esc.
ALMR115030	32,8x24,7	30x23	7	53,73 €
ALMR115035	38,5x28,2	35x26	8	78,12 €
ALMR115040	42,5x29,5	40x28	8	89,60 €
ALMR115045	47,8x31,5	45x30	8,5	102,18 €
ALMR115050	53x34,5	50x33	9,5	128,84 €
ALMR115055	57,5x37,5	55x36	10	134,93 €
ALMR115060	62,5x41,5	60x40	10	175,78 €
ALMR115065	67,5x44,5	65x43	10	195,14 €

COPERCHIO RETTANGOLARE PIANO
ANGOLI TONDI CON PONTICELLO INOX
PER ART. 150/151/1150

FLAT RECTANGULAR LID WITH ROUND
ANGLES FOR ART. 150/151



Code	cm	IVA esc.
ALMA183B30	30x23	23,61 €
ALMA183B35	35x26	30,95 €
ALMA183B40	40x28	35,57 €
ALMA183B45	45x30	36,68 €
ALMA183B50	50x33	42,56 €
ALMA183B55	55x36	46,72 €
ALMA183B60	60x40	56,11 €
ALMA183B65	65x43	62,98 €
ALMA183B70	70x45	84,68 €
ALMA183B80	80x50	95,83 €



PENTOLA ALTA CON DUE MANIGLIE INOX

STOCKPOT, 2 STAINLESS STEEL HANDLES

Code	Ø cm	H cm	lt	IVA esc.
ALMA10320	20	19	6	42.74 €
ALMA10324	24	22	10	56.41 €
ALMA10328	28	26	16	79.98 €
ALMA10332	32	30	24	98.04 €
ALMA10336	36	34	33.6	125.30 €
ALMA10340	40	38	46.5	142.62 €
ALMA10345	45	42	63	194.15 €
ALMA10350	50	47	88	230.00 €
ALMA10355	55	53	121	291.17 €
ALMA10360	60	56	158	341.23 €

CASSERUOLA ALTA
CON DUE MANIGLIE INOX

SAUCEPOT,
2 S/S HANDLES



Code	Ø cm	H cm	lt	IVA esc.
ALMA10420	20	11	3.3	30.72 €
ALMA10424	24	13	5.6	42.73 €
ALMA10428	28	15.5	9	58.96 €
ALMA10432	32	17	12.5	70.47 €
ALMA10436	36	19	18	94.76 €
ALMA10440	40	21	26	108.36 €
ALMA10445	45	24	35	142.55 €
ALMA10450	50	26	50	169.11 €
ALMA10455	55	29	65	229.13 €
ALMA10460	60	34	90	274.56 €

CASSERUOLA BASSA CON DUE MANIGLIE INOX

CASSEROLE POT,
2 S/S HANDLES



Code	Ø cm	H cm	lt	IVA esc.
ALMA10620	20	7	2,5	28,60 €
ALMA10624	24	8,5	4,1	34,66 €
ALMA10628	28	9,5	6,4	50,60 €
ALMA10632	32	10,5	8,4	64,39 €
ALMA10636	36	11,5	11,5	77,67 €
ALMA10640	40	14	17,6	95,19 €
ALMA10645	45	16	26,3	120,29 €
ALMA10650	50	17	32	150,70 €
ALMA10655	55	19	51,5	192,40 €
ALMA10660	60	21,5	60	228,94 €

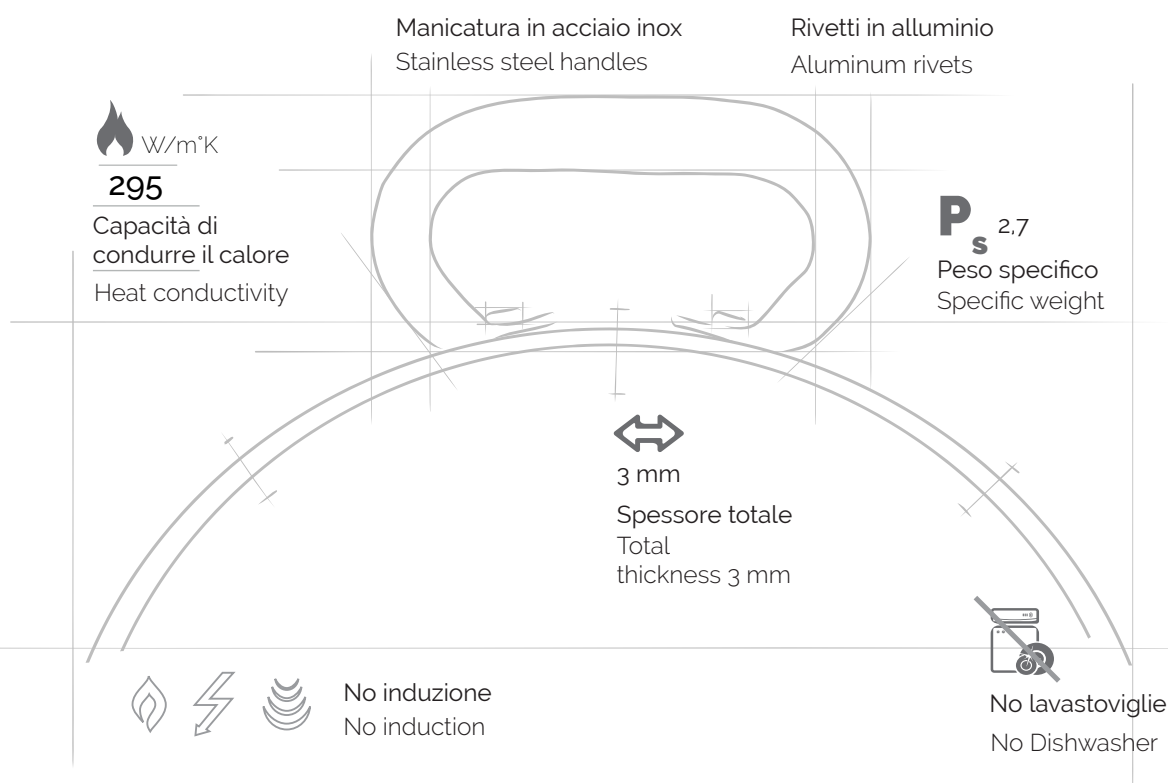

CASSERUOLA ALTA CON MANICO INOX

SAUCEPAN,
1 S/S HANDLE



Code	Ø cm	H cm	lt	IVA esc.
ALMA10514	14	7,5	1,5	21,37 €
ALMA10516	16	8	1,7	23,17 €
ALMA10518	18	10	2,6	25,82 €
ALMA10520	20	11	3,3	30,72 €
ALMA10524	24	13	5,6	42,73 €
ALMA10528	28	15,5	9	58,96 €
ALMA10532	32	17	12,5	70,47 €

ALLUMINIO

3 MM

AGNELLI SINCE 1907



CASSERUOLA OVALE CON COPERCHIO E DUE MANIGLIE INOX

OVAL SAUCEPOT WITH LID AND S/S HANDLES

Code	cm	H cm	lt	IVA esc.
ALMA12630	30x19	12	5.37	75,58 €
ALMA12632	32x22	13	7.19	79,40 €
ALMA12634	34x23	14	8.60	83,46 €
ALMA12636	36x25	15	10.60	102,20 €
ALMA12640	40x28	16	14.07	113,64 €
ALMA12650	50x36	17,5	24.74	150,59 €



CASSERUOLA BASSA CON MANICO INOX

CASSEROLE PAN,
1 S/S HANDLE

Code	Ø cm	H cm	lt	IVA esc.
ALMA10720	20	7	2.5	28,60 €
ALMA10724	24	8,5	4.1	34,66 €
ALMA10728	28	9,5	6.4	50,60 €
ALMA10732	32	10,5	8.4	64,39 €



TEGAME CON DUE MANIGLIE INOX

OMELETTE PAN, 2 S/S HANDLES

Code	cm	H cm	IVA esc.
ALMA11020	20	5	22,53 €
ALMA11024	24	5,5	29,21 €
ALMA11028	28	6	37,51 €
ALMA11032	32	6,5	41,97 €
ALMA11036	36	7	55,06 €
ALMA11040	40	7,2	66,22 €
ALMA11046	46	8	93,98 €
ALMA11050	50	8,5	116,81 €
ALMA11060	60	9	146,60 €



TEGAME OVALE PER PESCE
CON DUE MANIGLIE INOX

OVAL FISH PAN, 2 S/S HANDLES

Code	cm	H cm	IVA esc.
ALMA12030	30x19	6	39,91 €
ALMA12034	34x23	7	50,28 €



PADELLA DRITTA "FRIGGERE"
CON UN MANICO INOX "COOL"

FRYING PAN, "COOL" HANDLE

Code	Ø cm	H cm	IVA esc.
ALMC111C20	20	5	23,60 €
ALMC111C24	24	5,5	30,28 €
ALMC111C28	28	6	38,34 €
ALMC111C32	32	6,5	42,68 €
ALMC111C36	36	7	55,86 €
ALMC111C40	40	7,2	66,89 €



PADELLA RADIANTE CON MANICO INOX

FRYING PAN, 1 S/S HANDLE

Code	cm	H cm	IVA esc.
ALMA11120	20	5	21,91 €
ALMA11124	24	5,5	28,40 €
ALMA11128	28	6	36,49 €
ALMA11132	32	6,5	40,81 €
ALMA11136	36	7	53,55 €
ALMA11140	40	7,2	64,42 €
ALMA11146*	46	8	91,42 €
ALMA11150*	50	8,5	113,61 €
ALMA11160*	60	9	142,62 €

* con manico in lamiera * with sheet metal handle



PADELLA SVASATA ALTA
"SALTAPASTA" CON UN MANICO

SAUTÈ PAN "PASTA" WITH ONE HANDLE

Code	cm	H cm	IVA esc.
ALMA111B20	20	5,5	20,47 €
ALMA111B24	24	6,5	28,07 €
ALMA111B28	28	6,5	35,41 €
ALMA111B32	32	7,5	39,60 €
ALMA111B36	36	8	53,55 €
ALMA111B40	40	8,5	62,54 €
ALMA111B45*	45	9,5	91,42 €

* con manico in lamiera * with sheet metal handle



PADELLA SVASATA ALTA
"SALTAPASTA" CON UN MANICO "COOL"

SAUTÈ PAN "PASTA" WITH "COOL" HANDLE

Code	Ø cm	H cm	IVA esc.
ALMC111BC20	20	5,5	22,00 €
ALMC111BC24	24	6,5	29,35 €
ALMC111BC28	28	6,5	37,07 €
ALMC111BC32	32	7,5	41,76 €
ALMC111BC36	36	8	55,42 €
ALMC111BC40	40	8,5	64,57 €



PADELLA OVALE SVASATA PER PESCE
CON UN MANICO INOX

OVAL FISH PAN, 1 S/S HANDLE

Code	cm	H cm	IVA esc.
ALMA121B40	40x28	4,5	90,94 €
ALMA121B45	45x32	4,5	98,75 €



PADELLA SVASATA BASSA
CON UN MANICO INOX

LOW SAUTÉ PAN, 1 S/S HANDLE

Code	cm	H cm	IVA esc.
ALMA111BB20	20	4,5	19,19 €
ALMA111BB24	24	4,7	23,92 €
ALMA111BB28	28	5,3	29,77 €
ALMA111BB32	32	5,6	33,75 €
ALMA111BB36	36	5,8	44,10 €
ALMA111BB40	40	6	54,17 €



PADELLA SVASATA BASSA
CON UN MANICO INOX "COOL"

LOW SAUTÉ PAN, "COOL" HANDLE

Code	Ø cm	H cm	IVA esc.
ALMC111BBC20	20	4,5	20,98 €
ALMC111BBC24	24	5	25,51 €
ALMC111BBC28	28	5	31,20 €
ALMC111BBC32	32	5	35,47 €
ALMC111BBC36	36	5,5	45,93 €
ALMC111BBC40	40	6	56,04 €



PADELLA "MANTECARE" SALTA PASTA E
RISO CON UN MANICO INOX

CURVED SAUTÉ PAN

Code	cm	H cm	IVA esc.
ALMA111BM20	20	9	29,93 €
ALMA111BM24	24	9,5	38,35 €
ALMA111BM28	28	10	45,08 €
ALMA111BM32	32	10,5	53,87 €
ALMA111BM36	36	11	61,39 €



**COPERCHIO ROTONDO PESANTE CON
PONTICELLO INOX**

ROUND HEAVY LID WITH SMALL S/S
LOOP HANDLE PACK 10 PCS

Code	Ø cm	IVA esc.
ALMA12914	14	5,48 €
ALMA12916	16	6,03 €
ALMA12918	18	6,65 €
ALMA12920	20	11,18 €
ALMA12922	22	12,04 €
ALMA12924	24	12,64 €
ALMA12926	26	13,44 €
ALMA12928	28	15,70 €
ALMA12930	30	17,68 €
ALMA12932	32	19,61 €
ALMA12934	34	22,35 €
ALMA12936	36	23,74 €
ALMA12938	38	25,23 €
ALMA12940	40	27,18 €
ALMA12945	45	40,90 €
ALMA12950	50	48,95 €
ALMA12955	55	66,70 €
ALMA12960	60	79,65 €



**CASSERUOLA CON 4 COLAPASTA A
SPICCHIO ALTO CON DUE MANIGLIE INOX**

SAUCEPOT WITH 4 DEEP SEGMENT
COLANDERS

Code	Ø cm	H cm	lt	IVA esc.
ALMA15336	36	20	18	337,95 €
ALMA15340	40	22	26	401,33 €
ALMA15350	50	28	55	484,91 €



**COPERCHIO OVALE
CON PONTICELLO INOX**

OVAL LID

Code	cm	IVA esc.
ALMA129OV30	30x19	19,41 €
ALMA129OV32	32x22	22,35 €
ALMA129OV34	34x23	23,50 €
ALMA129OV36	36x25	24,98 €
ALMA129OV40	40x28	26,63 €
ALMA129OV50	50x36	66,70 €



**PENTOLA CUOCIVERDURA COUSCOUS
COPERCHIO CON CASSERUOLA PER
COTTURA A VAPORE CON MANICATURA
INOX**

SPECIAL VEGETABLES STOCKPOT WITH
CASSEROLE FOR STEAM COOKING

Code	Ø cm	H cm	lt	IVA esc.
ALMA15224	24	15x11	5	88,69 €
ALMA15228	28	17x13	9	108,72 €
ALMA15232	32	21x15	12	162,26 €
ALMA15236	36	22x17	18	199,04 €
ALMA15240	40	25x20	25	237,79 €



**SPICCHIO SINGOLO 1/4 ALTO
CON UN MANICO INOX**

SINGLE DEEP SEGMENT

Code	cm	H cm	IVA esc.
ALMA153B36	36	21	60,95 €
ALMA153B40	40	23	72,75 €
ALMA153B50	50	26	78,70 €



**COPERCHIO PER CASSERUOLA A 4
SPICCHI CON PONTICELLO INOX**

LID FOR 4-SEGMENT SAUCEPOT

Code	Ø cm	IVA esc.
ALMA153C36	36	40,90 €
ALMA153C40	40	45,02 €
ALMA153C50	50	60,61 €



**BACINELLA PER MARMELLATA CON DUE
MANIGLIE INOX**

ALUMINIUM JAM BOWL

Code	Ø cm	H cm	lt	IVA esc.
ALMA20236	36	16	11	52,40 €
ALMA20240	40	17	15	56,51 €
ALMA20245	45	17	20	69,82 €
ALMA20250	50	21	30	83,28 €
ALMA20260	60	26	47	148,95 €
ALMA20265	65	29	62	201,02 €



**COLAPASTA SFERICO (SCALDAPASTA)
CON UN MANICO E GANCIO INOX**

SPHERICAL COLANDER (PASTA HEATER)
WITH HANDLE AND HOOK

Code	Ø cm	H cm	IVA esc.
ALMA14020	20	13	23,00 €
ALMA14024	24	15	30,41 €



**COLAPASTA A TRE PIEDI CON DUE
MANIGLIE INOX**

TRIPODAL COLANDER, 2 S/S HANDLES

Code	cm	H cm	IVA esc.
ALMA11520	20	13	31,21 €
ALMA11522	22	14	33,38 €
ALMA11524	24	15	35,49 €
ALMA11526	26	15	38,11 €
ALMA11528	28	16,5	45,69 €
ALMA11530	30	16,5	48,95 €
ALMA11532	32	18,5	66,18 €



VAPORIERA RETTANGOLARE E
COPERCHIO CON MANICATURA INOX

RECTANGULAR STEAMER WITH LID

Code	cm	H cm	IVA esc.
ALMA151V40	40x28	16	149,95 €
ALMA151V45	45x30	16,5	179,67 €
ALMA151V50	50x33	17,5	215,60 €



PESCIERA CON GRIGLIA, COPERCHIO E
DUE MANIGLIE INOX

FISH KETTLE WITH GRID, LID AND S/S
HANDLES

Code	cm	H cm	IVA esc.
ALMA11840	40x13	10	70,31 €
ALMA11850	50x15	12	109,40 €
ALMA11860	60x17	13	128,59 €
ALMA11870	70x19	14	192,45 €
ALMA11880	80x24	17	256,36 €



PAIOLO PER POLENTA CON MANICO AD
ARCO IN FERRO

POLENTA POT, BOWED HANDLE

Code	Ø cm	H cm	lt	IVA esc.
ALMA14420	20	12,5	3	32,52 €
ALMA14422	22	15,5	3,5	35,34 €
ALMA14424	24	17	4,5	39,68 €
ALMA14426	26	18	6	46,17 €
ALMA14428	28	18	7	63,25 €
ALMA14430	30	21	8	65,37 €
ALMA14432	32	23	10	77,06 €
ALMA14434	34	24	15	85,73 €
ALMA14436	36	25	16	96,41 €
ALMA14438	38	26,5	17	102,80 €
ALMA14440	40	28	20	118,40 €
ALMA14444	44	33	30	192,45 €
ALMA14446	46	36	40	211,20 €
ALMA14452	52	38	50	239,91 €
ALMA14456	56	44	60	277,87 €
ALMA14458	58	45	75	315,63 €
ALMA14462	62	49	90	335,34 €
ALMA14464	64	55	120	397,57 €
ALMA14468	68	58	150	492,81 €

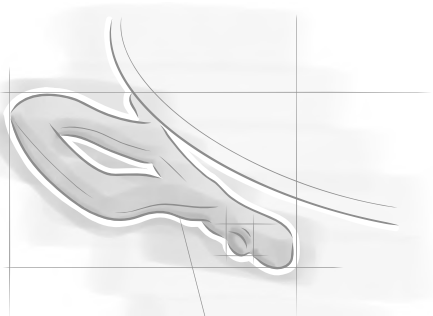

**PAIOLO PER POLENTA CON MANICO E
MANIGLIA IN ALLUMINIO**

POLENTA POT, ALUMINUM HANDLE

Code	Ø cm	H cm	lt	IVA esc.
ALMA16518	18	12	2	22,86 €
ALMA16520	20	13	3	25,31 €
ALMA16522	22	14	3,5	31,70 €
ALMA16524	24	14	4,5	34,66 €
ALMA16526	26	17	6	39,28 €
ALMA16528	28	17	7	46,33 €
ALMA16530	30	18	8	51,41 €
ALMA16532	32	19	10	77,20 €
ALMA16536	36	23	16	96,25 €
ALMA16540	40	26	20	118,40 €



**COLAPASTA CONICO (SCALDAPASTA)
CON UN MANICO E GANCIO INOX**

CONICAL COLANDER (PASTA HEATER), 1
S/S HANDLE AND HOOK

Code	cm	H cm	IVA esc.
ALMA17520	20	11,5	24,17 €
ALMA17524	24	14,5	31,70 €



COLAPASTA CONICO CON DUE MANIGLIE INOX

CONICAL COLANDER, 2 S/S HANDLES

Code	cm	H cm	IVA esc.
ALMA16830	30	18	82,62 €
ALMA16832	32	18	90,00 €
ALMA16835	35	21	108,24 €
ALMA16840	40	23	123,66 €

Serie alta con maniglie snodate senza rivetti
High series with hinged handles without rivets



**ROSTIERA RETTANGOLARE ANGOLI TONDI
PESANTE CON MANIGLIE INOX**

RECTANGULAR ROASTING PLATE, ROUND ANGLES, HEAVY-TYPE, DEEP WITH FOLDING ANGLES AND NO RIVETS

Code	est. cm	int. cm	H cm	IVA esc.
ALMA15030	33,5x23	30x23	7	39,40 €
ALMA15036	39x26	36x26	8	49,41 €
ALMA15040	43x28	40x28	8	57,04 €
ALMA15045	48,5x30	45x30	8,5	64,85 €
ALMA15050	54x33	50x33	9	81,19 €
ALMA15055	58,5x36	55x36	9,5	94,04 €
ALMA15060	64x40	60x40	10	113,73 €
ALMA15065	69x43	65x43	10	160,17 €
ALMA15070	74,5x45	70x45	11	179,70 €
ALMA15080	82,5x50	80x50	12,5	390,16 €
ALMA15090	92,5x50	90x50	13	437,04 €



GRIGLIA CON DUE MANIGLIE

GRILL WITH TWO HANDLES

Code	cm	IVA esc.
ALMA177G40	40x26	59,15 €
ALMA177G50	50x34	68,53 €
ALMA177G60	60x40	74,76 €
ALMA177G70	70x45	81,50 €



**COPERCHIO RETTANGOLARE A SOUTÈ (VASSOI)
CON ANGOLI TONDI E CON MANIGLIE LATERALI FISSE**

RECTANGULAR LID (TRAYS) WITH ROUND ANGLES AND FIXED SIDE HANDLES

Code	Ø cm	H cm	IVA esc.
ALMA18140	40x28	3,5	72,59 €
ALMA18150	50x34	3,5	75,67 €
ALMA18160	60x40	3,5	86,36 €
ALMA18170	70x45	3,5	104,78 €
ALMA18180	80x50	3,5	262,92 €



COPERCHIO RETTANGOLARE PIANO ANGOLI TONDI CON PONTICELLO INOX PER ART. 150/151/1150

FLAT RECTANGULAR LID WITH ROUND ANGLES FOR ART. 150/151

Code	cm	IVA esc.
ALMA183B30	30x23	24,32 €
ALMA183B35	35x26	31,88 €
ALMA183B40	40x28	36,64 €
ALMA183B45	45x30	37,79 €
ALMA183B50	50x33	43,84 €
ALMA183B55	55x36	48,13 €
ALMA183B60	60x40	57,80 €
ALMA183B65	65x43	64,87 €
ALMA183B70	70x45	87,23 €
ALMA183B80	80x50	98,71 €



BRASIERA RETTANGOLARE CON COPERCHIO A SOUTÈ SENZA GRIGLIA INTERNA

SEAFOOD TRAY, ALUMINUM

Code	cm	H cm	IVA esc.
ALMA177B40	40x26	16	211,46 €
ALMA177B50	50x34	16	234,56 €
ALMA177B60	60x40	20	275,98 €
ALMA177B70	70x45	20	718,51 €
ALMA177B80	80x50	20	894,46 €



INFARINAPESCE

POT FOR FLOURING FISH

Code	Ø cm	IVA esc.
ALMA29232	32	67,52 €
ALMA29236	36	83,28 €
ALMA29240	40	89,68 €



VASSOIO FRUTTI DI MARE

SEAFOOD TRAY, ALUMINUM

Code	Ø cm	H cm	IVA esc.
ALMA15824	24	4.5	12.43 €
ALMA15830	30	5.5	19.59 €
ALMA15836	36	5.5	21.46 €
ALMA15850	50	7.5	43.27 €



SUPPORTO ACCIAIO CROMATO PER ART. 158

CHROMED STEEL HOLDER FOR ART. 158

Code	Ø cm	H cm	IVA esc.
COIX158B	19-28	20	12.25 €
per vassoio di misura 24cm e 36cm			
COIX158C	30-40	20	24.71 €
per vassoio di misura 50cm			



COLAPASTA CILINDRICO CON DUE MANIGLIE FISSE INOX, SI INSERISCE NEGLI ART. 103 E 1103

CYLINDRIC COLANDER FOR INSERTION FOR ART. 103 OR 1103, FIXED S/S HANDLES

Code	cm	H cm	IVA esc.
ALMA17324	24	25	62.90 €
ALMA17328	28	29	96.41 €
ALMA17332	32	31	110.04 €
ALMA17336	36	37	134.17 €
ALMA17340	40	40	157.49 €
ALMA17345	45	43	221.38 €
ALMA17350	50	48	256.36 €



PENTOLA CON DUE MANIGLIE INOX

STOCKPOT, 2 HANDLES

Code	Ø cm	H cm	lt	IVA esc.
PCMX0320	20	18	5,5	28,80 €
PCMX0324	24	22	10	38,03 €
PCMX0328	28	26	16	51,07 €
PCMX0332	32	30	24	59,86 €
PCMX0336	36	34	35	79,05 €
PCMX0340	40	38	48	91,92 €
PCMX0346	46	44	73	136,07 €
PCMX0350	50	48	94	144,73 €



CASSERUOLA ALTA
CON DUE MANIGLIE INOX

SAUCEPOT, 2 HANDLES

Code	Ø cm	H cm	lt	IVA esc.
PCMX0416	16	9	1,9	19,01 €
PCMX0420	20	10,5	3,3	24,17 €
PCMX0424	24	13	5,5	28,35 €
PCMX0428	28	14	8,5	34,70 €
PCMX0432	32	16	12	49,02 €
PCMX0436	36	18	18	57,50 €
PCMX0440	40	20	25	63,80 €

CASSERUOLA BASSA CON DUE MANIGLIE INOX

CASSEROLE POT WITH TWO STAINLESS STEEL HANDLES



Code	Ø cm	H cm	lt	IVA esc.
PCMX0620	20	7,5	2,5	21,00 €
PCMX0624	24	9	4	27,20 €
PCMX0628	28	10	6	37,57 €
PCMX0632	32	11,5	8,5	46,67 €
PCMX0636	36	13	13	53,16 €
PCMX0640	40	14	17	62,89 €

CASSERUOLA ALTA CON UN MANICO INOX

SAUCEPAN, 1 HANDLE



Code	Ø cm	H cm	lt	IVA esc.
PCMX0516	16	9	1,9	18,06 €
PCMX0520	20	11	3,3	22,10 €
PCMX0524	24	13	5,5	27,84 €

TEGAME CON DUE MANIGLIE INOX

OMELETTE PAN, 2 HANDLES



Code	Ø cm	H cm	IVA esc.
PCMX01018	18	5	15,00 €
PCMX01020	20	6	15,97 €
PCMX01022	22	6	16,90 €
PCMX01024	24	6	17,65 €
PCMX01026	26	6	19,88 €
PCMX01028	28	6,5	21,05 €
PCMX01030	30	6,5	22,52 €
PCMX01032	32	6,5	24,64 €
PCMX01034	34	6,5	26,84 €
PCMX01036	36	7,5	28,60 €
PCMX01038	38	8	33,95 €
PCMX01040	40	8	35,21 €



PADELLA CON UN MANICO INOX

FRYPAN, 1 HANDLE

Code	Ø cm	H cm	IVA esc.
PCMX01118	18	5	14,22 €
PCMX01120	20	6	16,42 €
PCMX01124	24	6	18,30 €
PCMX01128	28	6,5	20,69 €
PCMX01132	32	6,5	23,81 €
PCMX01136	36	7,5	28,04 €
PCMX01140	40	8	34,09 €

COPERCHIO TONDO CON PONTICELLO IN ACCIAIO SENZA ORLO CONF. 10 PZ.

ROUND LID, LOOP HANDLE, NO RIM - PACK 10 PCS



Code	Ø cm	IVA esc.
PCMX02916	16	6,16 €
PCMX02918	18	6,55 €
PCMX02920	20	7,59 €
PCMX02922	22	8,55 €
PCMX02924	24	9,57 €
PCMX02926	26	10,08 €
PCMX02928	28	10,76 €
PCMX02930	30	11,93 €
PCMX02932	32	13,11 €
PCMX02934	34	15,48 €
PCMX02936	36	18,45 €
PCMX02938	38	19,89 €
PCMX02940	40	21,56 €



No induzione

No induction



**SCOLAPOMODORO (DA INSERIRE NELLE
PENTOLE POMODORO ART. 85 BIS)**

TOMATO COLANDER (FOR TOMATO
STOCKPOTS ART. 85 BIS)

Code	Ø cm	H cm	IVA esc.
FAMA85SC32	32	30	58,96 €
FAMA85SC36	36	34	72,41 €
FAMA85SC40	40	38	93,60 €
FAMA85SC46	46	44	122,04 €
FAMA85SC50	50	49	146,82 €



**TIPO NORD (PENTOLA) CON DUE MANIGLIE
IN ALLUMINIO - SENZA COPERCHIO
PESANTE**

NORTH TYPE (STOCKPOT), ALU HANDLES,
NO HEAVY LID

Code	Ø cm	H cm	lt	IVA esc.
FAMA85BS32	32	32	25	47,48 €
FAMA85BS36	36	36	36,5	56,95 €
FAMA85BS40	40	40	50,2	75,53 €
FAMA85BS46	46	46	76,5	95,14 €
FAMA85BS50	50	50	98	118,10 €

Agnelli
SINCE 1907

ALBLACK



ALLUMINIO
ANTIADERENTE

NON-STICK
ALUMINIUM



per tutti i piani di cottura
for all hobs



 **SPESORE 5MM** 5MM THICKNESS

**CASSERUOLA ALTA CON DUE
MANIGLIE INOX**

SAUCEPOT, 2 STAINLESS STEEL HANDLES

Code	Ø cm	Ø disco ind. cm	H cm	lt	IVA esc.
ALCX2104SSPI20	20	14,5	11	3,3	112,94 €
ALCX2104SSPI24	24	18	13	5,6	136,90 €
ALCX2104SSPI28	28	22	15,5	9	164,41 €



1,2mm

Spessore disco induzione
Induction disc thickness

Acciaio ferritico per induzione
Ferritic steel for induction



P_s 2.7

Peso specifico
Specific weight

Antiaderente interno ed esterno
Non-stick inside and outside



PFOA
FREE

Agnella
SINCE 1907

Manicatura in acciaio inox
Stainless steel handles



Lavabile in lavastoviglie
Dishwasher safe



per tutti i piani di cottura
for all hobs



 **SPESORE 5MM** 5MM THICKNESS

**CASSERUOLA BASSA
CON DUE MANIGLIE INOX**

CASSEROLE POT, 2 STAINLESS STEEL HANDLES

Code	Ø disco		H cm	lt	IVA esc.
	Ø cm	ind. cm			
ALCX2106SSPI24	24	18	9	4,1	121,98 €
ALCX2106SSPI28	28	22	9,5	6,4	149,28 €
ALCX2106SSPI32	32	24,5	10,5	8,4	173,64 €

ALBLACK AGNELLI SINCE 1907 ALLUMINIO ANTIADERENTE 3/5MM

ANTIADERENTE

 **SPESORE 5MM** 5MM THICKNESS

**CASSERUOLA ALTA
CON UN MANICO INOX**

SAUCEPAN, TUBULAR HANDLE



Code	Ø cm	Ø disco ind. cm	H cm	lt	IVA esc.
ALCX2105SSPI16	16	13	11	2,0	82,60 €
ALCX2105SSPI20	20	14,5	11	3,3	100,85 €

 **SPESORE 5MM** 5MM THICKNESS

**CASSERUOLA BASSA
CON UN MANICO INOX**

CASSEROLE PAN, 1 S/S HANDLE



Code	Ø cm	Ø disco ind. cm	H cm	lt	IVA esc.
ALCX2107SSPI20	20	14,5	7	2,5	92,84 €
ALCX2107SSPI24	24	18	9	4,1	108,36 €

 **SPESORE 3MM** 3MM THICKNESS

PADELLA SVASATA ALTA
"SALTAPASTA" CON UN MANICO

SAUTÈ PAN "PASTA" WITH ONE HANDLE



Code	Ø cm	Ø disco ind. cm	H cm	IVA esc.
ALCX111BSSPI24	24	13	6,5	75,20 €
ALCX111BSSPI28	28	15,5	7,2	84,11 €
ALCX111BSSPI32	32	18,5	7,5	99,72 €



COPERCHIO IN VETRO
CON POMELLO IN ACCIAIO

GLASS LID WITH STEEL KNOB

Code	Ø cm	IVA esc.
ALCX129VE16	16	€ 27,71
ALCX129VE20	20	€ 28,31
ALCX129VE24	24	€ 28,95
ALCX129VE28	28	€ 29,96
ALCX129VE32	32	€ 31,83

ALBLACK ALLUMINIO ANTIADERENTE 5MM

AGNELLI SINCE 1907

ANTIADERENTE



 SPESSORE 5MM 5MM THICKNESS

**CASSERUOLA ALTA
CON DUE MANIGLIE INOX**

SAUCEPOT, 2 S/S HANDLES

Code	Ø cm	Ø disco ind. cm	H cm	lt	IVA esc.
ALSA2104SSPI16	16	13	11	2,0	67,18 €
ALSA2104SSPI20	20	14,5	11	3,3	89,27 €
ALSA2104SSPI24	24	18	14	5,6	113,71 €
ALSA2104SSPI28	28	22	16	9	138,05 €
ALSA2104SSPI32	32	24,5	18	12,5	162,24 €



 SPESSORE 5MM 5MM THICKNESS

**CASSERUOLA BASSA CON DUE
MANIGLIE INOX**

Casserole pot, 2 s/s handles

Code	Ø cm	Ø disco ind. cm	H cm	lt	IVA esc.
ALSA2106SSPI20	20	14,5	7	2,5	81,13 €
ALSA2106SSPI24	24	18	9	4,1	98,50 €
ALSA2106SSPI28	28	22	9,5	6,4	122,63 €
ALSA2106SSPI32	32	24,5	10,5	7,4	147,43 €



 **SPESORE 5MM** 5MM THICKNESS

**CASSERUOLA ALTA
CON UN MANICO INOX "COOL"**

SAUCEPAN, "COOL" S/S TUBULAR HANDLE

Code	Ø cm	Ø disco ind. cm	H cm	lt	IVA esc.
ALSC2105SSPIC16	16	13	11	2,0	70,75 €
ALSC2105SSPIC20	20	14,5	11	3,3	88,82 €
ALSC2105SSPIC24	24	18	14	5,6	111,72 €



 **SPESORE 5MM** 5MM THICKNESS

**CASSERUOLA BASSA CON UN
MANICO INOX "COOL"**

CASSEROLE PAN, 1 "COOL" S/S HANDLE

Code	Ø cm	Ø disco ind. cm	H cm	lt	IVA esc.
ALSC2107SSPIC20	20	14,5	7	2,5	80,67 €
ALSC2107SSPIC24	24	18	9	4,1	96,50 €
ALSC2107SSPIC28	28	22	9,5	6,4	120,95 €

ALBLACK ALLUMINIO ANTIADERENTE 3/5MM

AGNELLI SINCE 1907

ANTIADERENTE



 **SPESORE 5MM** 5MM THICKNESS

TEGAME CON DUE MANIGLIE INOX

OMELETTE PAN, 2 S/S HANDLES

Code	Ø cm	Ø disco ind. cm	H cm	IVA esc.
ALSA2110SSPI20	20	14,5	5,5	72,41 €
ALSA2110SSPI24	24	18	6	88,61 €
ALSA2110SSPI28	28	22	6,5	107,02 €
ALSA2110SSPI32	32	24,5	7	127,36 €



 **SPESORE 5MM** 5MM THICKNESS

**PADELLA DRITTA CON UN MANICO INOX
"COOL"**

FRYING PAN, INDUCTION BOTTOM, "COOL" HANDLE

Code	Ø cm	Ø disco ind. cm	H cm	IVA esc.
ALSC2111SSPIC20	20	14,5	5,5	72,31 €
ALSC2111SSPIC24	24	18	6	87,65 €
ALSC2111SSPIC28	28	22	6,5	105,41 €
ALSC2111SSPIC32	32	24,5	7	126,84 €



COPERCHIO IN VETRO CON
POMELLO IN ACCIAIO

GLASS LID WITH STEEL KNOB

Code	Ø cm	IVA esc.
ALCX129VE16	16	€ 27,71
ALCX129VE20	20	€ 28,31
ALCX129VE24	24	€ 28,95
ALCX129VE28	28	€ 29,96
ALCX129VE32	32	€ 31,83



 SPESSORE 3MM 3MM THICKNESS

PADELLA SVASATA ALTA
"SALTAPASTA" CON UN MANICO "COOL"

SAUTÈ PAN "PASTA" WITH "COOL" HANDLE

Code	Ø cm	Ø disco ind. cm	H cm	IVA esc.
ALSC111BSSPIC24	24	13	6,5	63,05 €
ALSC111BSSPIC28	28	15,5	7,2	70,75 €
ALSC111BSSPIC32	32	18,5	7,5	81,59 €
ALSC111BSSPIC36	36	22,5	8	94,69 €

Agnelli
SINCE 1907

GENETIC MUTATION
SHARK
POWERED GREBLON TECHNOLOGY
SKIN

ALLUMINIO
ANTIADERENTE

NON-STICK
ALUMINIUM



per tutti i piani di cottura
for all hobs



CASSERUOLA ALTA
CON DUE MANIGLIE INOX

SAUCEPOT, 2 S/S HANDLES



Code	Ø cm	Ø disco ind. cm	H cm	lt	IVA esc.
ALSA104GPI20	20	14,5	8	1,7	94,82 €
ALSA104GPI24	24	18	11	3,3	111,87 €
ALSA104GPI28	28	22	13	5,6	134,87 €
ALSA104GPI32	32	24,5	15,5	9	163,57 €

ANTIADERENTE



Spessore disco induzione
Induction disc thickness

1,2mm

Acciaio ferritico per induzione
Ferritic steel for induction



P_s 2,7 Peso specifico

Specific weight



No lavastoviglie
No Dishwasher



CASSERUOLA BASSA CON
DUE MANIGLIE INOX

CASSEROLE POT, 2 S/S HANDLES



Code	Ø cm	Ø disco ind. cm	H cm	lt	IVA esc.
ALSA106GPI20	20	14,5	9	4,1	85,83 €
ALSA106GPI24	24	18	9,5	6,4	99,83 €
ALSA106GPI28	28	22	10,5	8,4	116,89 €
ALSA106GPI32	32	24,5	11,5	11,5	142,31 €

La superficie ruvida è in grado di esaltare le cotture più tecniche. "L'alta rugosità" forma micro crateri in grado di fornire prestazioni di durata e di distribuzione di calore mai raggiunte.

The high roughness forms micro craters that can provide durability performance and heat distribution never achieved.



PFOA
FREE

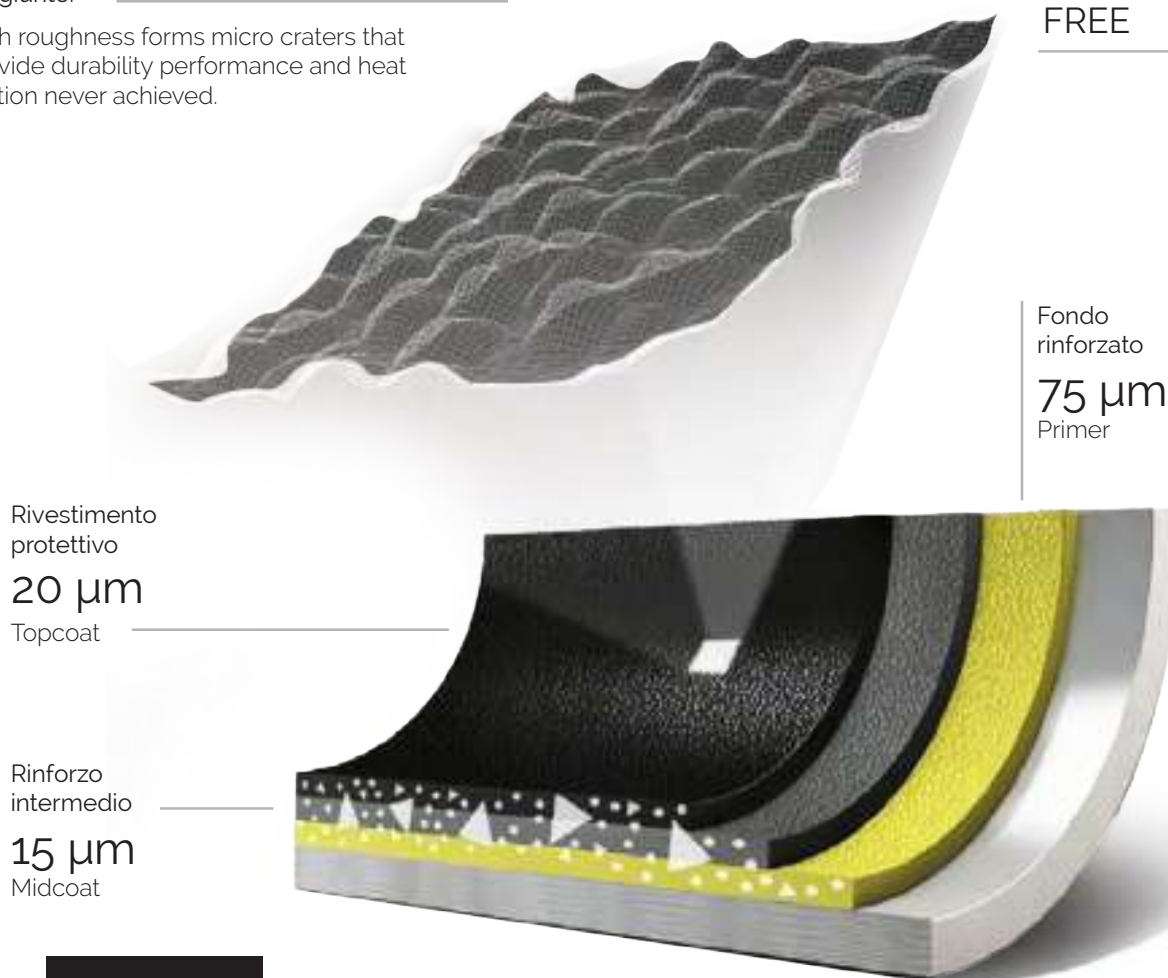

Rivestimento
protettivo

20 µm

Topcoat

Rinforzo
intermedio

15 µm

Midcoat

110 µm

Shark Skin

40 µm

Normale antiaderente
Normal non-stick

Alluminio

3 mm

Aluminium



CASSERUOLA ALTA CON UN MANICO INOX "COOL"

Saucepan, "Cool" s/s tubular handle

Code	Ø cm	Ø disco ind. cm	H cm	lt	IVA esc.
ALSC105GPIC16	16	13	8	1,7	81,97 €
ALSC105GCPI20	20	14,5	11	3,3	92,83 €
ALSC105GPIC24	24	18	13	5,6	107,72 €
ALSC105GPIC28	28	22	15,5	9	133,89 €



CASSERUOLA BASSA CON UN MANICO INOX "COOL"

CASSEROLE PAN, 1 "COOL" S/S HANDLE

Code	Ø cm	Ø disco ind. cm	H cm	lt	IVA esc.
ALSC107GPIC20	20	14,5	9	4,1	84,45 €
ALSC107GPIC24	24	18	9,5	6,4	96,27 €
ALSC107GPIC28	28	22	10,5	8,4	114,40 €



TEGAME CON DUE MANIGLIE INOX

OMELETTE PAN, 2 S/S HANDLES

Code	Ø cm	Ø disco ind. cm	H cm	IVA esc.
ALSA110GPI20	20	14,5	5,5	80,38 €
ALSA110GPI24	24	18	6	89,41 €
ALSA110GPI28	28	22	6,5	102,84 €
ALSA110GPI32	32	24,5	7	116,43 €



PADELLA SVASATA ALTA "SALTAPASTA" CON UN MANICO "COOL"

SAUTÈ PAN "PASTA" WITH "COOL" HANDLE

Code	Ø cm	Ø disco ind. cm	H cm	IVA esc.
ALSC111BGPIC24	24	12,52	6,5	75,73 €
ALSC111BGPIC28	28	15	7	83,62 €
ALSC111BGPIC32	32	18,5	7,5	92,85 €
ALSC111BGPIC36	36	22,5	8	106,51 €

Agnelli
SINCE 1907

GENETIC MUTATION
SHARK
POWERED GREBLON TECHNOLOGY SKIN

ALLUMINIO
ANTIADERENTE
NON-STICK
ALUMINIUM



No induzione
No induction



CASSERUOLA ALTA CON
DUE MANIGLIE INOX

SAUCEPOT, 2 S/S HANDLES

Code	Ø cm	H cm	lt	IVA esc.
ALSA104G16	16	8	1,7	44,77 €
ALSA104G20	20	11	3,3	54,93 €
ALSA104G24	24	13	5,6	73,92 €
ALSA104G28	28	15,5	9	112,75 €
ALSA104G32	32	17	12,5	142,88 €
ALSA104G36	36	19	18	176,62 €
ALSA104G40	40	21	26	213,95 €



CASSERUOLA BASSA CON
DUE MANIGLIE INOX

CASSEROLE POT, 2 S/S HANDLES

Code	Ø cm	H cm	lt	IVA esc.
ALSA106G24	24	9	4,1	66,68 €
ALSA106G28	28	9,5	6,4	97,00 €
ALSA106G32	32	10,5	8,4	123,20 €
ALSA106G36	36	11,5	11,5	140,00 €
ALSA106G40	40	14	17,6	171,51 €

SHARK SKIN ALLUMINIO ANTIADERENTE 3MM

AGNELLI SINCE 1907



CASSERUOLA ALTA CON UN MANICO INOX "COOL"

SAUCEPAN, "COOL" S/S TUBULAR HANDLE

Code	Ø cm	H cm	lt	IVA esc.
ALSC105GC16	16	8	1,7	46,07 €
ALSC105GC20	20	11	3,3	53,89 €
ALSC105GC24	24	13	5,6	72,82 €
ALSC105GC28	28	15,5	9	112,75 €



CASSERUOLA BASSA CON UN MANICO INOX "COOL"

CASSEROLE PAN, 1 "COOL" S/S HANDLE

Code	Ø cm	H cm	lt	IVA esc.
ALSC107GC24	24	9	4,1	66,68 €
ALSC107GC28	28	9,5	6,4	97,00 €
ALSC107GC32	32	10,5	8,4	123,20 €



TEGAME CON DUE MANIGLIE INOX

OMELETTE PAN, 2 S/S HANDLES

Code	Ø cm	H cm	IVA esc.
ALSA110G20	20	4,5	39,13 €
ALSA110G24	24	5,5	49,65 €
ALSA110G28	28	6	64,36 €
ALSA110G32	32	6,5	76,11 €
ALSA110G36	36	7	97,58 €
ALSA110G40	40	7,5	114,50 €



PADELLA SVASATA ALTA
"SALTAPASTA" CON UN MANICO "COOL"

SAUTÈ PAN "PASTA" WITH "COOL" HANDLE

Code	Ø cm	H cm	IVA esc.
ALSC111BGC20	20	5,5	38,11 €
ALSC111BGC24	24	6,5	47,43 €
ALSC111BGC28	28	7	61,10 €
ALSC111BGC32	32	7,5	72,83 €
ALSC111BGC36	36	8	93,02 €
ALSC111BGC40	40	8,5	108,34 €

PADELLA SVASATA ALTA "SALTAPASTA"
SAUTÈ PAN "PASTA"



PROFILO SLANCIATO, IDEALE PER SALTARE E
MESCOLARE CON AGILITÀ.

SLENDER PROFILE, IDEAL FOR TOSSING AND
STIRRING WITH EASE.

SVASATA BASSA
LOW FLARED



FONDO AMPIO E STABILE,
GARANTISCE MAGGIORE SPAZIO DI LAVORO

WIDE AND STABLE BASE,
PROVIDES MORE WORKING SPACE.



PADELLA SVASATA BASSA
CON UN MANICO INOX "COOL"

LOW SAUTÉ PAN, 1 TUBULAR HANDLE

Code	Ø cm	H cm	IVA esc.
ALSC111BBGC20	20	4,5	36,01 €
ALSC111BBGC24	24	5	45,13 €
ALSC111BBGC28	28	5	56,21 €
ALSC111BBGC32	32	5	66,69 €
ALSC111BBGC36	36	5,5	83,59 €
ALSC111BBGC40	40	6	95,66 €

Agnelli
SINCE 1907

ALBLACK



ALLUMINIO
ANTIADERENTE 5MM

5MM NON-STICK
ALUMINIUM



No induzione
No induction

P_s 2.7

Peso specifico
Specific weight



W/m²K

295

Capacità di
condurre il calore
Heat conductivity



3mm

Spessore totale
Total thickness 3 mm

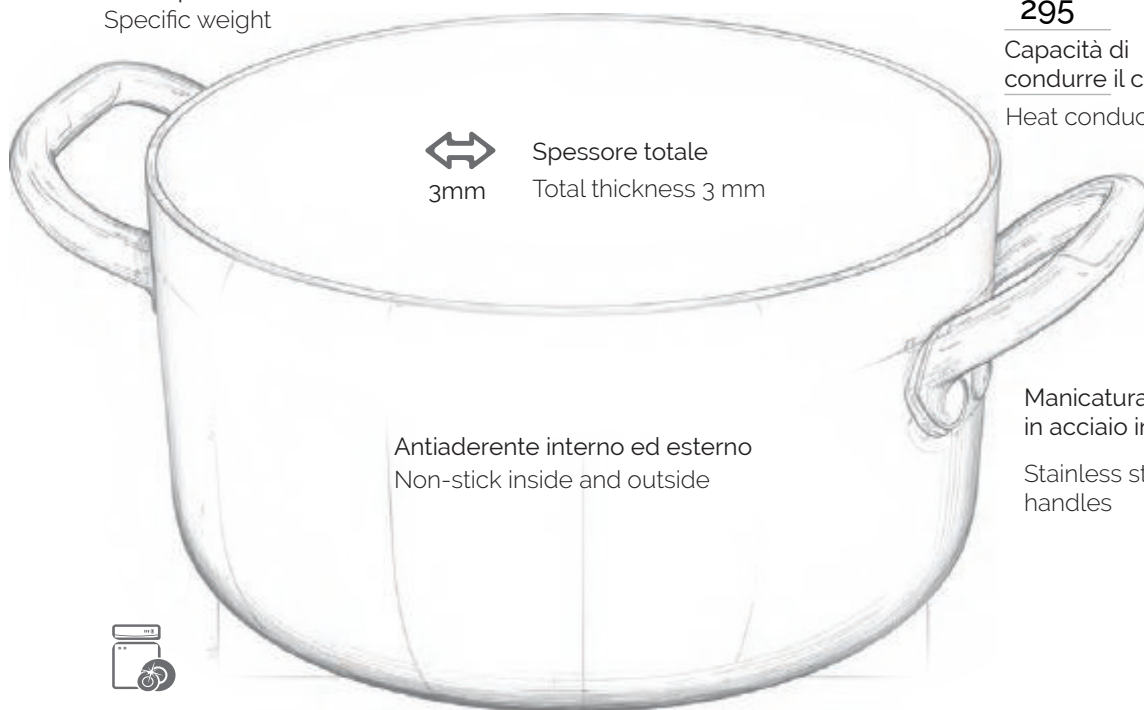

Antiaderente interno ed esterno
Non-stick inside and outside

Manicatura
in acciaio inox

Stainless steel
handles



Lavabile in lavastoviglie
Dishwasher safe



CASSERUOLA ALTA RADIANTE CON DUE MANIGLIE INOX

SAUCEPOT, 2 S/S HANDLES

Code	Ø cm	H cm	lt	IVA esc.
ALSA2104SS16	16	11	2,0	50,95 €
ALSA2104SS20	20	11,5	3,3	66,24 €
ALSA2104SS24	24	14	5,6	89,12 €
ALSA2104SS28	28	16	9	123,70 €
ALSA2104SS32	32	18	12,5	145,98 €
ALSA2104SS36	36	19,5	18	182,44 €

CASSERUOLA BASSA RADIANTE CON DUE MANIGLIE INOX

CASSEROLE POT, 2 S/S HANDLES



Code	Ø cm	H cm	lt	IVA esc.
ALSA2106SS20	20	7	2,5	182,44 €
ALSA2106SS24	24	9	4,1	58,21 €
ALSA2106SS28	28	9,2	6,4	74,60 €
ALSA2106SS32	32	10,5	8,4	102,48 €
ALSA2106SS36	36	11,5	11,5	124,78 €
ALSA2106SS40	40	14	17,6	149,85 €



CASSERUOLA ALTA RADIANTE CON UN MANICO INOX "COOL"

SAUCEPAN, "COOL" S/S TUBULAR HANDLE

Code	Ø cm	H cm	lt	IVA esc.
ALSC2105SSC16	16	11	2,0	51,98 €
ALSC2105SSC20	20	11,5	3,3	68,34 €
ALSC2105SSC24	24	14	5,6	91,27 €



CASSERUOLA BASSA RADIANTE CON UN MANICO INOX "COOL"

CASSEROLE PAN, 1 "COOL" S/S HANDLE

Code	Ø cm	H cm	lt	IVA esc.
ALSC2107SSC20	20	7	2,5	59,70 €
ALSC2107SSC24	24	9	4,1	77,29 €
ALSC2107SSC28	28	9,2	6,4	104,99 €
ALSC2107SSC32	32	10,5	8,4	130,55 €

**TEGAME RADIANTE CON DUE
MANIGLIE INOX**

OMELETTE PAN, 2 S/S HANDLES



Code	Ø cm	H cm	IVA esc.
ALSA2110SS20	20	4,5	48,99 €
ALSA2110SS24	24	4,5	59,95 €
ALSA2110SS28	28	5	71,48 €
ALSA2110SS32	32	6	86,55 €
ALSA2110SS36	36	7	104,26 €
ALSA2110SS40	40	7,5	114,61 €
ALSA2110SS45	45	8	127,08 €
ALSA2110SS50	50	8,5	145,45 €

**PADELLA RADIANTE CON UN MANICO IN
STILE FRANCESE**

FRENCH PAN WITH FLAT IRON HANDLE



Code	Ø cm	H cm	IVA esc.
ALSA2111FBSS20	20	4,5	33,58 €
ALSA2111FBSS24	24	4,5	41,44 €
ALSA2111FBSS28	28	5	47,70 €
ALSA2111FBSS32	32	6	55,46 €
ALSA2111FBSS36	36	7	65,05 €
ALSA2111FBSS40	40	7,5	78,42 €

**PADELLA RADIANTE CON UN MANICO
INOX "COOL"**

STRAIGHT FRYING PAN, RECTIFIED BOTTOM.
"COOL" HANDLE



Code	Ø cm	H cm	IVA esc.
ALSC2111SSC20	20	4,5	50,09 €
ALSC2111SSC24	24	4,5	60,95 €
ALSC2111SSC28	28	5	72,41 €
ALSC2111SSC32	32	6	88,41 €
ALSC2111SSC36	36	7	105,43 €
ALSC2111SSC40	40	7,5	116,51 €

Agnelli
SINCE 1907

ALLUMINIO
ANTIADERENTE 5MM

5MM NON-STICK
ALUMINIUM



No induzione
No induction



No lavastoviglie
No Dishwasher

CASSERUOLA ALTA RADIANTE CON DUE MANIGLIE INOX

SAUCEPOT, 2 S/S HANDLES

Code	Ø cm	H cm	lt	IVA esc.
ALSA2104S20	20	11,5	3,3	67,69 €
ALSA2104S24	24	14	5,6	90,16 €
ALSA2104S28	28	16	9	125,14 €
ALSA2104S32	32	18	12,5	147,67 €
ALSA2104S36	36	19,5	18	184,55 €
ALSA2104S40	40	22	12,5	227,50 €
ALSA2104S45	45	25	18	301,03 €

CASSERUOLA BASSA RADIANTE CON DUE MANIGLIE INOX

CASSEROLE POT, 2 S/S HANDLES

Code	Ø cm	H cm	lt	IVA esc.
ALSA2106S20	20	7	2,5	58,31 €
ALSA2106S24	24	8	3,7	76,20 €
ALSA2106S28	28	9	5,6	104,70 €
ALSA2106S32	32	10	8	127,48 €
ALSA2106S36	36	12	12	153,08 €
ALSA2106S40	40	13	16	169,12 €
ALSA2106S45	45	15	23	209,24 €



**CASSERUOLA ALTA RADIANTE CON UN
MANICO INOX**

SAUCEPAN, "COOL" S/S
TUBULAR HANDLE

Code	Ø cm	H cm	lt	IVA esc.
ALSA2105S16	16	11	2,0	49,62 €
ALSA2105S18	18	10	2,6	60,29 €
ALSA2105S20	20	11,5	3,3	66,53 €
ALSA2105S24	24	14	5,6	88,80 €
ALSA2105S28	28	16	9	122,28 €
ALSA2105S32	32	18	12,5	133,12 €



**CASSERUOLA BASSA RADIANTE CON
UN MANICO INOX**

CASSEROLE PAN, 1 "COOL"
S/S HANDLE

Code	Ø cm	H cm	lt	IVA esc.
ALSA2107S20	20	7	2,5	57,56 €
ALSA2107S24	24	8	3,7	75,23 €
ALSA2107S28	28	9	5,6	102,18 €
ALSA2107S32	32	10	8	125,80 €



TEGAME CON DUE MANIGLIE INOX

OMELETTE PAN, 2 S/S HANDLES

Code	Ø cm	H cm	IVA esc.
ALSA2110S20	20	4,5	50,10 €
ALSA2110S24	24	5	61,89 €
ALSA2110S28	28	6	74,55 €
ALSA2110S32	32	6,5	89,34 €
ALSA2110S36	36	7,5	107,62 €
ALSA2110S40	40	7,5	118,30 €



PADELLA RADIANTE CON UN MANICO INOX

FRYING PAN, S/S TUBULAR HANDLE, RECTIFIED BOTTOM

Code	Ø cm	H cm	IVA esc.
ALSA2111S16	16	4	43,55 €
ALSA2111S20	20	4,5	50,61 €
ALSA2111S24	24	6	62,48 €
ALSA2111S28	28	6,5	74,55 €
ALSA2111S32	32	6,5	89,34 €
ALSA2111S36	36	7,5	107,62 €
ALSA2111S40	40	7,5	118,30 €



Rivetti in alluminio
Aluminum rivets



PADELLA RADIANTE CON UN MANICO INOX "COOL"

FRYING PAN, RECTIFIED BOTTOM, "COOL" HANDLE

Code	Ø cm	H cm	IVA esc.
ALSC2111SC20	20	4,5	52,17 €
ALSC2111SC24	24	5	64,78 €
ALSC2111SC28	28	6	76,97 €
ALSC2111SC32	32	6,5	92,12 €
ALSC2111SC36	36	7,5	109,86 €
ALSC2111SC40	40	7,5	122,56 €

ALLUMINIO ANTIADERENTE 5MM
5MM NON-STICK ALUMINUM

AGNELLI SINCE 1907



PADELLA SVASATA ALTA
"SALTAPASTA" CON UN MANICO

SAUTÈ PAN "PASTA" WITH ONE HANDLE

Code	Ø cm	H cm	IVA esc.
ALSA2111BS20	20	5,5	48,03 €
ALSA2111BS24	24	6,5	56,33 €
ALSA2111BS28	28	7	68,71 €
ALSA2111BS32	32	7,5	85,12 €
ALSA2111BS36	36	8	103,04 €
ALSA2111BS40	40	8,5	117,18 €



PADELLA SVASATA ALTA
"SALTAPASTA" CON UN MANICO "COOL"

SAUTÈ PAN "PASTA" WITH "COOL" HANDLE

Code	Ø cm	H cm	IVA esc.
ALSC2111BSC20	20	5,5	49,81 €
ALSC2111BSC24	24	6,5	58,28 €
ALSC2111BSC28	28	7	70,16 €
ALSC2111BSC32	32	7,5	87,94 €
ALSC2111BSC36	36	8	106,32 €
ALSC2111BSC40	40	8,5	120,30 €



PADELLA RADIANTE "MANTECARE" SALTA
PASTA E RISO CON UN MANICO INOX

CURVED SAUTÉ PAN WITH S/S TUBULAR HANDLE

Code	Ø cm	H cm	IVA esc.
ALSA2111BMS20	20	9	54,56 €
ALSA2111BMS24	24	9,5	74,55 €
ALSA2111BMS28	28	10	87,58 €
ALSA2111BMS32	32	10,5	108,78 €
ALSA2111BMS36	36	11	132,78 €



WOK RADIANTE FONDO PIANO
CON UN MANICO INOX

WOK WITH FLAT BOTTOM

Code	Ø cm	H cm	IVA esc.
ALSA2111WPS28	28	9,5	87,70 €
ALSA2111WPS32	32	10	111,13 €

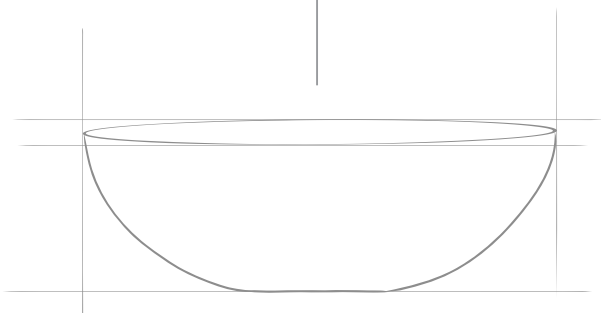

FONDO PIANO
FLAT BOTTOM

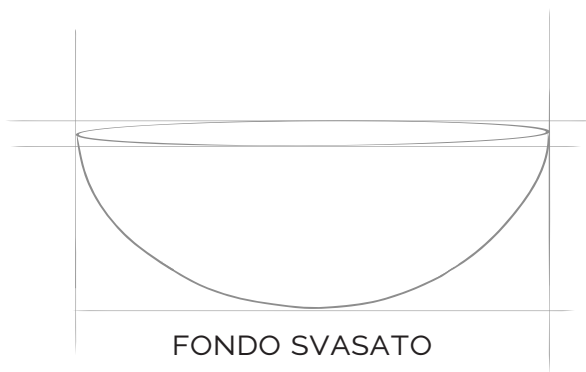

FONDO SVASATO
SHAPED BOTTOM



WOK RADIANTE FONDO SVASATO
CON UN MANICO INOX

WOK WITH SHAPED BOTTOM

Code	Ø cm	H cm	IVA esc.
ALSA2111WS28	28	9,1	104,33 €
ALSA2111WS32	32	10	125,95 €

Agnelli
SINCE 1907

ALBLACK



ALLUMINIO
ANTIADERENTE 3MM
3MM NON-STICK
ALUMINIUM



No induzione
No induction



**CASSERUOLA ALTA
CON DUE MANIGLIE INOX**

SAUCEPOT, 2 S/S HANDLES

Code	Ø cm	H cm	lt	IVA esc.
ALSA104SS16	16	8	1,7	41,82 €
ALSA104SS20	20	11	3,3	49,84 €
ALSA104SS24	24	13	5,6	66,41 €
ALSA104SS28	28	15,5	9	102,31 €
ALSA104SS32	32	17	12,5	128,36 €
ALSA104SS36	36	19	18	158,69 €



**CASSERUOLA BASSA
CON DUE MANIGLIE INOX**

CASSEROLE POT, 2 S/S HANDLES

Code	Ø cm	H cm	lt	IVA esc.
ALSA106SS20	20	7	2,5	48,70 €
ALSA106SS24	24	9	4,1	60,50 €
ALSA106SS28	28	9,5	6,4	88,03 €
ALSA106SS32	32	10,5	8,4	111,81 €
ALSA106SS36	36	11,5	11,5	127,05 €
ALSA106SS40	40	14	17,6	154,08 €



TEGAME CON DUE MANIGLIE INOX

OMELETTE PAN, 2 S/S HANDLES

Code	Ø cm	H cm	IVA esc.
ALSA110SS20	20	4,5	35,53 €
ALSA110SS24	24	5,5	44,58 €
ALSA110SS28	28	6	57,82 €
ALSA110SS32	32	6,5	67,70 €
ALSA110SS36	36	7	88,54 €
ALSA110SS40	40	7,5	102,86 €



CASSERUOLA ALTA CON UN MANICO INOX "COOL"

SAUCEPAN, "COOL" S/S TUBULAR HANDLE

Code	Ø cm	H cm	lt	IVA esc.
ALSC105SSC16	16	8	1,7	43,88 €
ALSC105SSC20	20	11	3,3	50,79 €
ALSC105SSC24	24	13	5,6	67,99 €



Spessore totale
Total thickness 3 mm

P_s 2.7

Peso specifico
Specific weight

Antiaderente
interno ed esterno

Non-stick
inside and outside

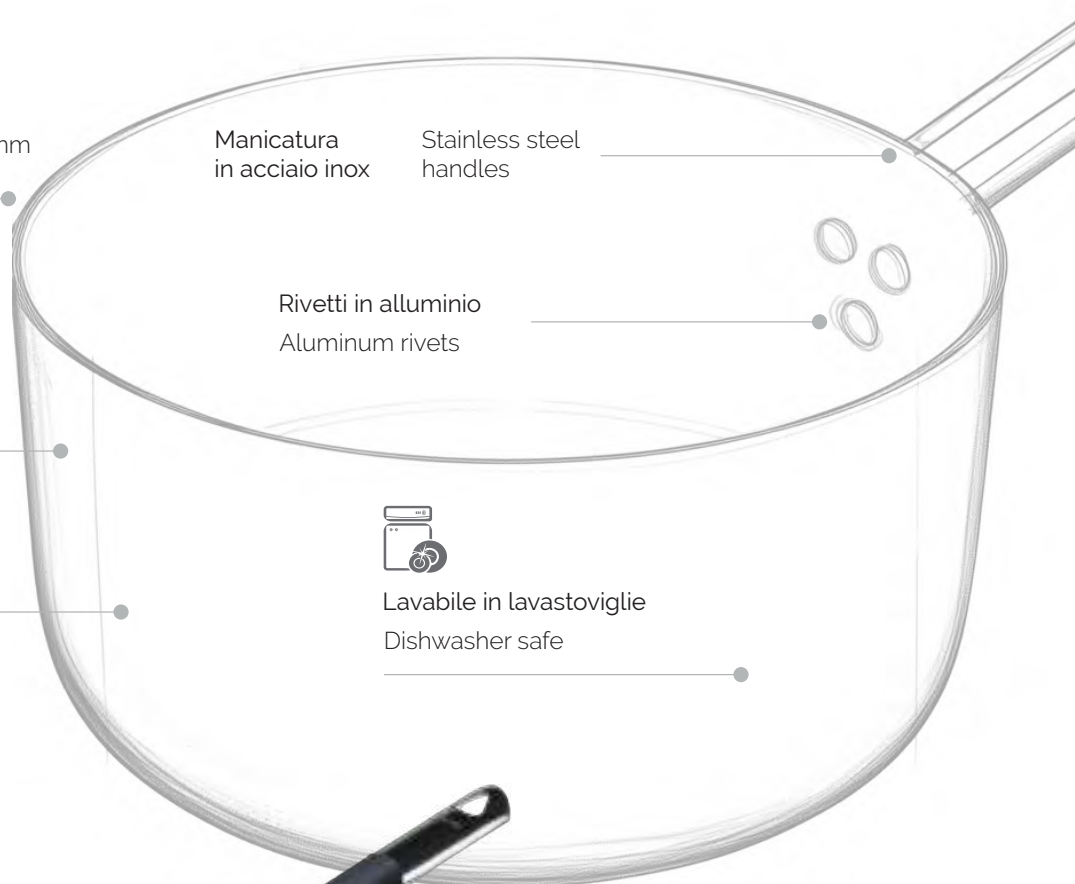

Manicatura
in acciaio inox

Stainless steel
handles

Rivetti in alluminio
Aluminum rivets



Lavabile in lavastoviglie
Dishwasher safe



CASSERUOLA BASSA CON UN MANICO INOX "COOL"

CASSEROLE PAN, 1 "COOL" S/S HANDLE

Code	Ø cm	H cm	lt	IVA esc.
ALSC107SSC20	20	7	2,5	51,11 €
ALSC107SSC24	24	9	4,1	63,53 €
ALSC107SSC28	28	9,5	6,4	92,43 €
ALSC107SSC32	32	10,5	8,4	117,38 €



**PADELLA SVASATA ALTA
"SALTAPASTA" CON UN MANICO "COOL"**

SAUTÈ PAN "PASTA" WITH "COOL" HANDLE

Code	Ø cm	H cm	IVA esc.
ALSC111BSSC20	20	5,5	34,74 €
ALSC111BSSC24	24	6,5	43,69 €
ALSC111BSSC28	28	7	50,78 €
ALSC111BSSC32	32	7,5	60,53 €
ALSC111BSSC36	36	8	71,30 €
ALSC111BSSC40	40	8,5	83,18 €

PADELLA SVASATA ALTA "SALTAPASTA"
SAUTÈ PAN "PASTA"

**PROFILO SLANCIATO, IDEALE PER SALTARE E
MESCOLARE CON AGILITÀ.**

SLENDER PROFILE, IDEAL FOR TOSSING AND
STIRRING WITH EASE.

SVASATA BASSA
LOW FLARED

**FONDO AMPIO E STABILE,
GARANTISCE MAGGIORE SPAZIO DI LAVORO**

WIDE AND STABLE BASE,
PROVIDES MORE WORKING SPACE.



**PADELLA SVASATA BASSA
CON UN MANICO INOX "COOL"**

LOW SAUTÈ PAN. "COOL" HANDLE

Code	Ø cm	H cm	IVA esc.
ALSC111BBSSC20	20	4,5	32,45 €
ALSC111BBSSC24	24	5	38,11 €
ALSC111BBSSC28	28	5	44,67 €
ALSC111BBSSC32	32	5	53,15 €
ALSC111BBSSC36	36	5,5	62,22 €
ALSC111BBSSC40	40	6	72,53 €

Agnelli
SINCE 1907

ALLUMINIO
ANTIADERENTE 3MM

3MM NON-STICK
ALUMINIUM



No induzione
No induction



No lavastoviglie
No Dishwasher



CASSERUOLA ALTA CON DUE MANIGLIE INOX

SAUCEPOT, 2 S/S HANDLES

Code	Ø cm	H cm	lt	IVA esc.
ALSA104S16	16	8	1,6	41,91 €
ALSA104S18	18	10	2,6	45,47 €
ALSA104S20	20	11	3,3	49,95 €
ALSA104S24	24	13	5,6	67,18 €
ALSA104S28	28	15,5	9	102,51 €
ALSA104S32	32	17	12,5	129,89 €
ALSA104S36	36	19	18	160,56 €
ALSA104S40	40	21	26	194,48 €
ALSA104S45	45	24	35	225,31 €



CASSERUOLA BASSA CON DUE MANIGLIE INOX

CASSEROLE POT, 2 S/S HANDLES

Code	Ø cm	H cm	lt	IVA esc.
ALSA106S24	24	9	4,1	60,61 €
ALSA106S28	28	9,5	6,4	88,19 €
ALSA106S32	32	10,5	8,4	112,02 €
ALSA106S36	36	11,5	11,5	127,28 €
ALSA106S40	40	14	17,6	155,93 €
ALSA106S45	45	16	26,3	186,11 €



**CASSERUOLA ALTA CON UN
MANICO INOX**

SAUCEPAN, "COOL" S/S TUBULAR HANDLE

Code	Ø cm	H cm	lt	IVA esc.
ALSA105S16	16	8	1,7	41,91 €
ALSA105S18	18	10	2,6	45,02 €
ALSA105S20	20	11	3,3	49,41 €
ALSA105S24	24	13	5,6	66,19 €
ALSA105S28	28	15,5	9	102,51 €



**CASSERUOLA BASSA
CON UN MANICO INOX**

CASSEROLE PAN, 1 "COOL" S/S HANDLE

Code	Ø cm	H cm	lt	IVA esc.
ALSA107S24	24	9	4,1	60,61 €
ALSA107S28	28	9,5	6,4	88,19 €



TEGAME CON DUE MANIGLIE INOX

OMELETTE PAN, 2 S/S HANDLES

Code	Ø cm	H cm	IVA esc.
ALSA110S20	20	4,5	35,59 €
ALSA110S24	24	5,5	45,12 €
ALSA110S28	28	6	58,50 €
ALSA110S32	32	6,5	69,19 €
ALSA110S36	36	7	88,70 €
ALSA110S40	40	7,5	104,09 €
ALSA110S45	45	8	151,89 €
ALSA110S50	50	8,5	229,09 €
ALSA110S60	60	9	283,97 €



PADELLA DRITTA "FRIGGERE" CON UN
MANICO INOX "COOL"

FRYING PAN, 3 MM (1/8") THICK, "COOL"
HANDLE

Code	Ø cm	H cm	IVA esc.
ALSC111SC20	20	4.5	36.64 €
ALSC111SC24	24	5.5	45.78 €
ALSC111SC28	28	6	63.48 €
ALSC111SC32	32	6.5	69.50 €
ALSC111SC36	36	7	88.78 €
ALSC111SC40	40	7.5	103.37 €



PADELLA DRITTA "FRIGGERE" CON UN
MANICO INOX

FRYING PAN, 3 MM (1/8") THICK, 1 HANDLE

Code	Ø cm	H cm	IVA esc.
ALSA111S20	20	4.5	34.61 €
ALSA111S24	24	5.5	43.88 €
ALSA111S28	28	6	56.89 €
ALSA111S32	32	6.5	67.32 €
ALSA111S36	36	7	86.29 €
ALSA111S40	40	7.5	101.24 €
ALSA111S45*	45	8	147.67 €
ALSA111S50*	50	8.5	220.66 €
ALSA111S60*	60	9	273.55 €

* con manico in lamiera

* with sheet metal handle



PADELLA SVASATA ALTA
"SALTAPASTA" CON UN MANICO "COOL"

SAUTÈ PAN "PASTA" WITH "COOL" HANDLE

Code	Ø cm	H cm	IVA esc.
ALSC111BSC20	20	5,5	36,32 €
ALSC111BSC24	24	6,5	45,16 €
ALSC111BSC28	28	7	58,19 €
ALSC111BSC32	32	7,5	69,33 €
ALSC111BSC36	36	8	88,62 €
ALSC111BSC40	40	8,5	103,20 €



PADELLA SVASATA ALTA
"SALTAPASTA" CON UN MANICO INOX

SAUTÈ PAN "PASTA" WITH 1 HANDLE

Code	Ø cm	H cm	IVA esc.
ALSA111BS20	20	5,5	34,61 €
ALSA111BS24	24	6,5	43,88 €
ALSA111BS28	28	7	56,35 €
ALSA111BS32	32	7,5	67,32 €
ALSA111BS36	36	8	86,29 €
ALSA111BS40	40	8,5	100,25 €
ALSA111BS45*	45	9,5	147,67 €



PADELLA SVASATA BASSA CON UN MANICO INOX "COOL"

LOW SAUTÈ PAN, 3 MM (1/8") THICK, "COOL" HANDLE

Code	Ø cm	H cm	IVA esc.
ALSC111BBSC20	20	4.5	34.29 €
ALSC111BBSC24	24	4.5	42.99 €
ALSC111BBSC28	28	5	53.53 €
ALSC111BBSC32	32	5	63.49 €
ALSC111BBSC36	36	5.5	79.60 €
ALSC111BBSC40	40	6	91.10 €



PADELLA SVASATA BASSA CON UN MANICO INOX

LOW SAUTÈ PAN, 3 MM (1/8") THICK, 1 HANDLE

Code	Ø cm	H cm	IVA esc.
ALSA111BBS20	20	4.5	32.93 €
ALSA111BBS24	24	4.5	41.29 €
ALSA111BBS28	28	5	51.84 €
ALSA111BBS32	32	5	61.77 €
ALSA111BBS36	36	5.5	77.45 €
ALSA111BBS40	40	6	88.78 €

ALLUMINIO ANTIADERENTE 3MM
3MM NON-STICK ALUMINUM

AGNELLI SINCE 1907



TEGAME OVALE PER PESCE CON DUE MANIGLIE INOX

OVAL FISH PAN, 2 S/S HANDLES

Code	cm	H cm	IVA esc.
ALSA120S30	30x19	6	57,78 €
ALSA120S34	34x23	6,5	62,83 €



CASSERUOLA OVALE CON DUE MANIGLIE INOX E COPERCHIO

OVAL SAUCEPOT, 2 S/S HANDLES AND LID

Code	cm	H cm	lt	IVA esc.
ALSA126S32	32x22	14	7,74	107,92 €
ALSA126S36	36x25	15,5	10,96	133,04 €

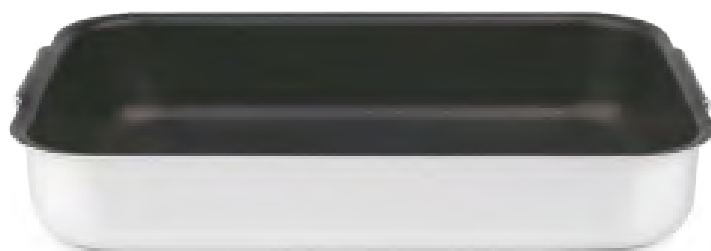

ROSTIERA RETTANGOLARE CON DUE MANIGLIE SNODATE

RECTANGULAR ROASTING PLATE,
2 FOLDING HANDLES

Code	est. cm	int. cm	H cm	IVA esc.
ALSA150S30	33x24,8	30x23	6,5	86,93 €
ALSA150S35	38,5x28,3	35x26	7	96,58 €
ALSA150S40	42,7x29,7	40x28	8	108,08 €
ALSA150S45	48x31,8	45x30	8,5	130,40 €
ALSA150S50	53,7x34,7	50x33	9	153,72 €
ALSA150S60	63,5x42	60x40	10	203,37 €



**PAIOLLO CON UN MANICO E UNA
MANIGLIA INOX**

POLENTA POT, S/S HANDLE AND HAND GRIP

Code	Ø cm	H cm	lt	IVA esc.
ALSA165S24	24	14	4,5	73,27 €
ALSA165S26	26	17	6	81,30 €
ALSA165S28	28	17	7	93,80 €
ALSA165S30	30	18	8	101,67 €
ALSA165S32	32	19	10	114,16 €



**PADELLA CRESPELLE (PER CRÊPES)
CON UN MANICO INOX**

PANCAKE PAN (FOR CRÊPES)

Code	Ø cm	IVA esc.
ALSA111CR24	24	39,91 €



**PADELLA OVALE SVASATA PER PESCE
CON UN MANICO INOX**

OVAL FRYPAN, 1 S/S TUBULAR HANDLE

Code	cm	H cm	IVA esc.
ALSA121BS40	40x28	4,5	123,15 €
ALSA121BS45	45x32	4,5	132,91 €

Agnelli
SINCE 1907

EFFETTO
PIETRA

EFFECT
STONE

ALLUMINIO
ANTIADERENTE 3MM

3MM NON-STICK
ALUMINIUM



No induzione
No induction

ANTIADERENTE



**PADELLA SVASATA ALTA
"SALTAPASTA" CON UN MANICO "COOL"**

SAUTÈ PAN "PASTA" WITH "COOL" HANDLE

Code	Ø cm	H cm	IVA esc.
ALSA111BINF20	20	5,5	40,05 €
ALSA111BINF24	24	6,5	43,24 €
ALSA111BINF28	28	7	48,96 €
ALSA111BINF32	32	7,5	57,21 €
ALSA111BINF36	36	8	65,54 €
ALSA111BINF40	40	8,5	72,61 €



**PADELLA SVASATA BASSA
CON UN MANICO INOX "COOL"**

LOW SAUTÈ PAN, 3 MM THICK. "COOL" HANDLE

Code	Ø cm	H cm	IVA esc.
ALSA111BBINF20	20	4,5	39,07 €
ALSA111BBINF24	24	5	42,48 €
ALSA111BBINF28	28	5	47,21 €
ALSA111BBINF32	32	5	55,18 €
ALSA111BBINF36	36	7,5	62,22 €
ALSA111BBINF40	40	7,5	68,96 €



No induzione
No induction



TEGAME CON DUE MANIGLIE INOX

OMELETTE PAN, 2 S/S HANDLES

Code	Ø cm	H cm	IVA esc.
FAMA10SEL20	20	5,5	32,19 €
FAMA10SEL24	24	6,5	36,70 €
FAMA10SEL28	28	7	45,31 €
FAMA10SEL32	32	7,5	55,83 €
FAMA10SEL36	36	8	64,63 €
FAMA10SEL40	40	8,5	74,27 €



PADELLA SVASATA ALTA "SALTAPASTA" CON UN MANICO "COOL"

SAUTÉ PAN "PASTA" WITH "COOL" HANDLE

Code	Ø cm	H cm	IVA esc.
FAMA11BSEL20	20	5,5	32,19 €
FAMA11BSEL24	24	6,5	36,70 €
FAMA11BSEL28	28	7	45,31 €
FAMA11BSEL32	32	7,5	55,83 €
FAMA11BSEL36	36	8	64,63 €
FAMA11BSEL40	40	8,5	74,27 €



PADELLA SVASATA BASSA CON UN MANICO INOX

LOW SAUTÉ PAN, 1 S/S HANDLE

Code	Ø cm	H cm	IVA esc.
FAMA11BBSEL20	20	4,5	30,86 €
FAMA11BBSEL24	24	5	34,85 €
FAMA11BBSEL28	28	5	42,54 €
FAMA11BBSEL32	32	5	52,79 €
FAMA11BBSEL36	36	5,5	62,09 €
FAMA11BBSEL40	40	6	71,73 €

Agnelli
SINCE 1907

UPSIDE DOWN

COPPER 3

FINITURA
MARTELLATA

HAMMERED
FINISH



No induzione
No induction

W/m²K
189

Capacità di
condurre il calore
Heat conductivity

Prima il piattino fa da
coperchio
First the saucer acts
as a lid

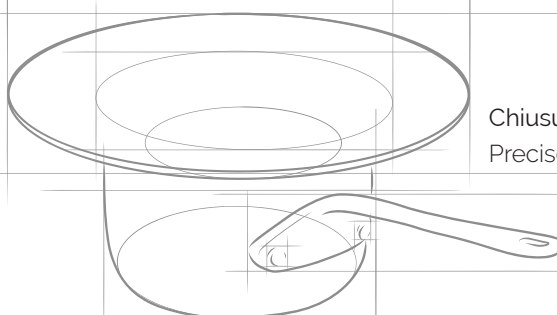

Chiusura a incastro preciso
Precise snap-fit closure



3 mm
Spessore totale
Total thickness 3 mm



Ideale per
monoporzioni in forno
Ideal for single
portions in the oven

ACCIAIO INOX 18/10
18/10 STAINLESS STEEL

PER UNA FACILE PULIZIA
FOR EASY CLEANING

ALLUMINIO
ALUMINUM

PER UNA PERFETTA TRASMISSIONE DEL CALORE
FOR PERFECT HEAT DISTRIBUTION

RAME
COPPER

PER UNA FASCINO SENZA EGUALI
FOR AN UNPARALLELED CHARM



CASSERUOLINO A 1 MANICO CON BECCO A DESTRA A SERVIRE IN COPPER3

COPPER 3 MINI SAUCEPAN
WITH 1 HANDLE AND SPOUT ON THE RIGHT



Code	Ø cm	H cm	Master	Inner	IVA esc.
COTE105CIT05	5,4	3	12	1	€ 26,83
COTE105CIT07	7,4	4	12	1	€ 33,69
COTE105CIT09	9	5	12	1	€ 40,36
COTE105CIT12S	12,5	6	12	1	€ 55,45

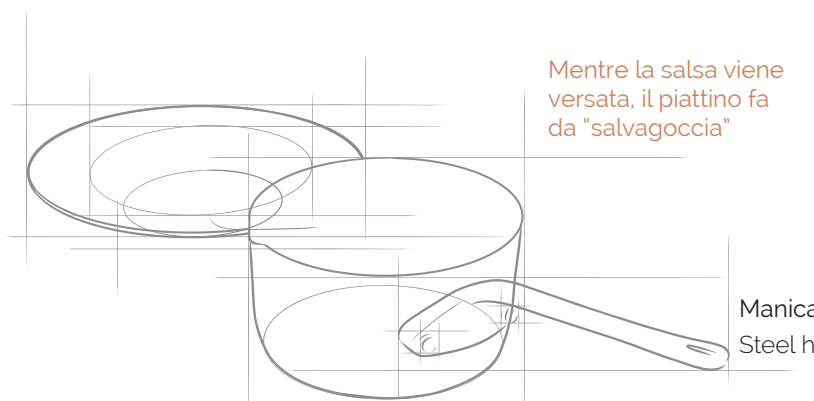

Mentre la salsa viene versata, il piattino fa da "salvagoccia"

While the sauce is being poured, the plate acts as a "drip saver"

Manicatura in acciaio
Steel handle

hammered finish
hammered finish

Per tornare in cucina, il casseruolino viene appoggiato sul piattino, così da garantire la massima pulizia.

Before returning to the kitchen, the small saucepan is placed on the saucer to ensure maximum cleanliness.

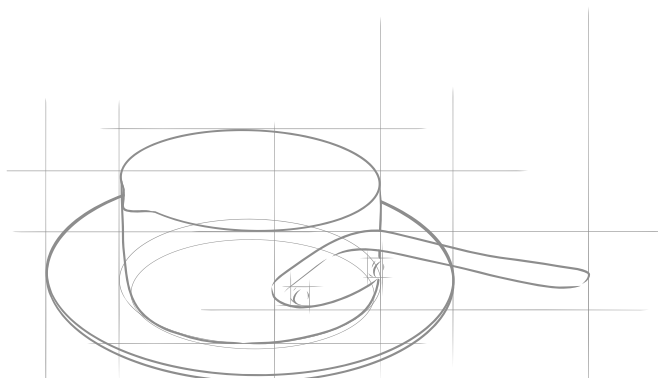

Grazie alla sua forma, il piattino permette un perfetto incastro con il casseruolino

Thanks to its shape, the saucer allows for a perfect fit with the saucepan.



MINIPIATTO MARTELLATO IN COPPER 3

COPPER 3 MINI-PLATE

Code	Ø cm	H cm	Master	Inner	IVA esc.
COTEPLATEM05	8,8	1,9	12	1	€ 18,00
COTEPLATEM07	11,8	2,3	12	1	€ 23,60
COTEPLATEM09	14	2,4	12	1	€ 28,90

Agnelli
SINCE 1907

UPSIDE DOWN

ALU-INOX

FINITURA
MARTELLATA

HAMMERED
FINISH



per tutti i piani di cottura
for all hobs



CASSERUOLINO A 1 MANICO
CON BECCO A DESTRA A SERVIRE IN 3PLY

3PLY MINI SAUCEPAN
WITH 1 HANDLE AND SPOUT ON THE RIGHT

Code	Ø cm	H cm	Master	Inner	IVA esc.
ALUM10505	5,4	3	12	1	€ 24,27
ALUM10507	7,4	4	12	1	€ 28,01
ALUM10509	9	5	12	1	€ 32,82
ALUM10512S	12,5	6	12	1	€ 39,16

ACCIAIO INOX 18/10

18/10 STAINLESS STEEL

PER UNA FACILE PULIZIA

FOR EASY CLEANING

ALLUMINIO

ALUMINUM

PER UNA PERFETTA TRASMISSIONE DEL CALORE

FOR PERFECT HEAT DISTRIBUTION

ACCIAIO FERRITICO

FERRITIC STEEL

PER L'INDUZIONE

FOR INDUCTION COOKING



MINIPIATTO MARTELLATO IN 3PLY

3PLY MINI-PLATE

Code	Ø cm	H cm	Ma-ster	Inner	IVA esc.
ALUMPLATEM05	8,8	1,9	12	1	€ 15,44
ALUMPLATEM07	11,8	2,3	12	1	€ 19,10
ALUMPLATEM09	14	2,4	12	1	€ 23,50



MINI ALZATA PER MINIPIATTO MARTELLATO

MINI STAND FOR HAMMERED MINI-PLATE

Code	Ø cm	H cm	Master	Inner	IVA esc.
COIX158MS1	5,4-7,4	4	12	1	5,30 €
COIX158MS2	7,4-9	4	12	1	6,89 €



SET COMPLETO DI 3 MINIPIATTINI E 2 ALZATINE

Il set comprende:

N. 1 mini piattino in 3ply

ALUMPLATE05

N. 1 mini piattino in 3ply

ALUMPLATE07

N. 1 mini piattino in 3ply

ALUMPLATE09

N. 1 MINI ALZATINA COIX158MS1

N. 1 MINI ALZATINA COIX158MS2

The set includes:

N. 1 mini-plate in 3ply

ALUMPLATE05

N. 1 mini-plate in 3ply

ALUMPLATE07

N. 1 mini-plate in 3ply

ALUMPLATE09

N. 1 MINI STAND COIX158MS1

N. 1 MINI STAND COIX158MS2

Code	IVA esc.
ALUM158KIT	€ 70,00

Agnelli
SINCE 1907

LINEA 1932

1932 COLLECTION

ALLUMINIO 3MM
3MM ALUMINIUM



No induzione
No induction

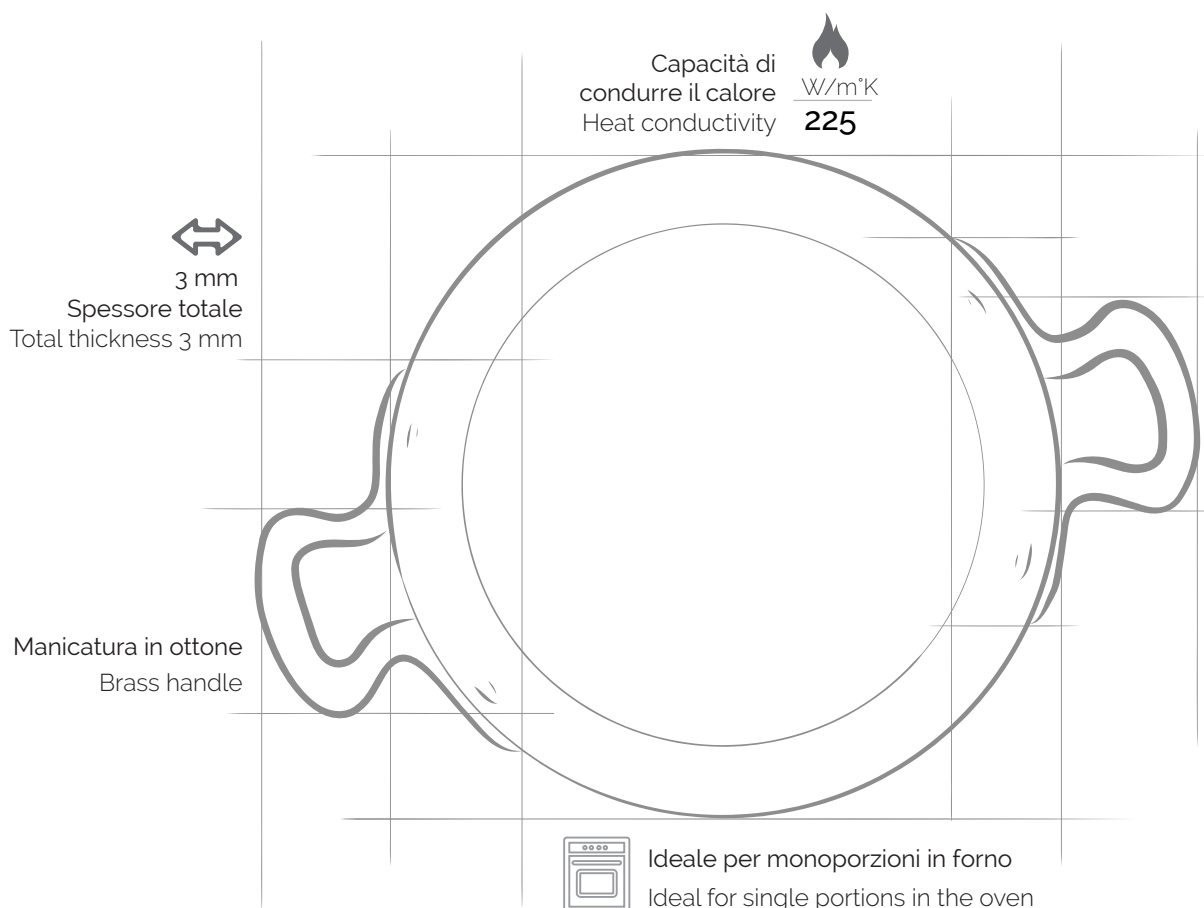

CASSERUOLINO ALTO
CON DUE MANIGLIE IN OTTONE

TWO-HANDLES HIGH LITTLE SAUCEPOT

Code	Ø cm	H cm	lt	IVA esc.
ALMA10410	10	7	0,55	25,24 €



CASSERUOLINO BASSO CON DUE MANIGLIE IN OTTONE

TWO-HANDLE LOW LITTLE CASSEROLE POT

Code	Ø cm	H cm	lt	IVA esc.
ALMA10610	10	4.5	0.35	23.69 €

STESSA FORMA,
nuova storia...

NATA COME GIOCO PER BAMBINI
NEL 1932, OGGI TORNA IN TAVOLA
NEI RISTORANTI, CON LA STESSA
FORMA E UN NUOVO SIGNIFICATO.

SAME SHAPE,
new story...

BORN AS A CHILDREN'S TOY IN 1932, TODAY
IT RETURNS TO THE TABLE OF RESTAURANTS —
SAME SHAPE, NEW MEANING.

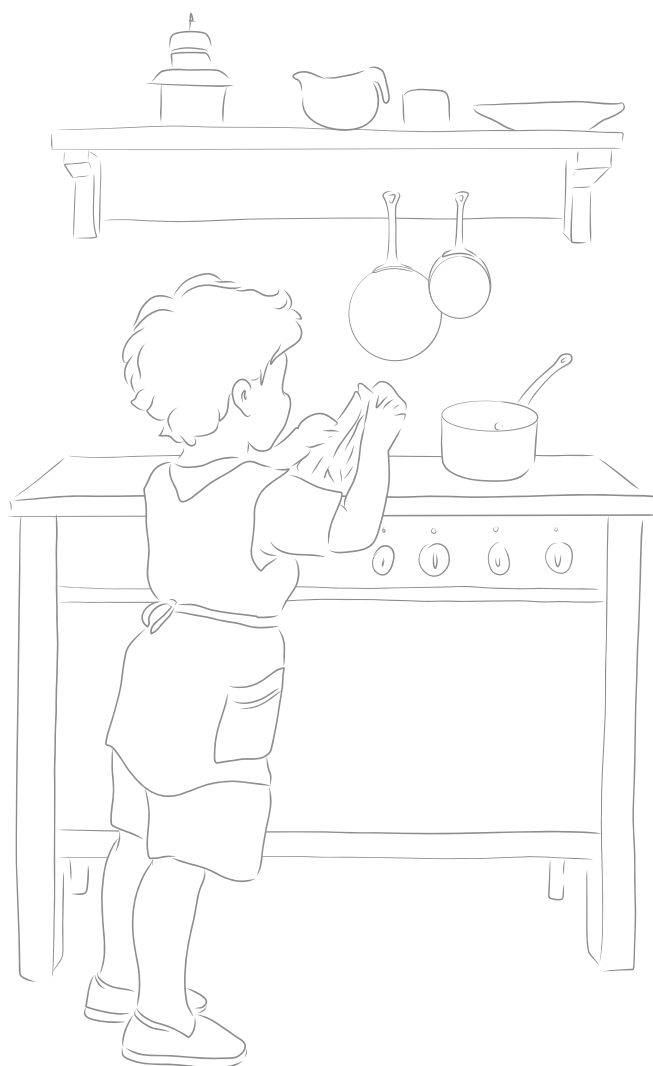

CASSERUOLINO ALTO CON UN MANICO IN OTTONE

ONE-HANDLE HIGH LITTLE SAUCEPAN

Code	Ø cm	H cm	lt	IVA esc.
ALMA10510	10	7	0.55	22.57 €



TEGAMINO
CON DUE MANIGLIE IN OTTONE

TWO-HANDLE LITTLE OMELETTE PAN

Code	Ø cm	H cm	IVA esc.
ALMA11010	10	3	24,21 €
ALMA11012	12	3,5	24,72 €
ALMA11014	14	4	25,24 €
ALMA11016	16	4	26,27 €
ALMA11020S	20	4,5	28,33 €



CASSERUOLINO BASSO
CON UN MANICO IN OTTONE

ONE-HANDLE LOW LITTLE CASSEROLE PAN

Code	Ø cm	H cm	lt	IVA esc.
ALMA10710	10	4,5	0,35	21,63 €



PADELLINO
CON UN MANICO IN OTTONE

LITTLE PAN WITH BRASS HANDLES

Code	Ø cm	H cm	IVA esc.
ALMA11110	10	3	20,40 €
ALMA11112	12	3,5	21,05 €
ALMA11114	14	4	22,66 €
ALMA11116	16	4	23,69 €



COPERCHIO 1932
CON PONTICELLO IN OTTONE

1932 COLLECTION LID WITH BRASS HANDLE

Code	cm	IVA esc.
FAMO2910	10	10,72 €
FAMO2912	12	11,54 €
FAMO2914	14	11,54 €
FAMO2916	16	12,45 €



**CASSERUOLINO ALTO
CON DUE MANIGLIE INOX**

TWO-HANDLE HIGH LITTLE SAUCEPOT

Code	Ø cm	H cm	lt	IVA esc.
ALCX10412S	12	7	0.79	39.11 €
ALCX10414S	14	7.5	1.15	41.05 €



**CASSERUOLINO BASSO
CON DUE MANIGLIE INOX**

TWO-HANDLE LOW LITTLE CASSEROLE POT

Code	Ø cm	H cm	lt	IVA esc.
ALCX10612S	12	4.5	0.51	37.99 €
ALCX10614S	14	5.5	0.85	39.12 €

Manicatura 1907
in acciaio inox

Handle 1907
in stainless steel

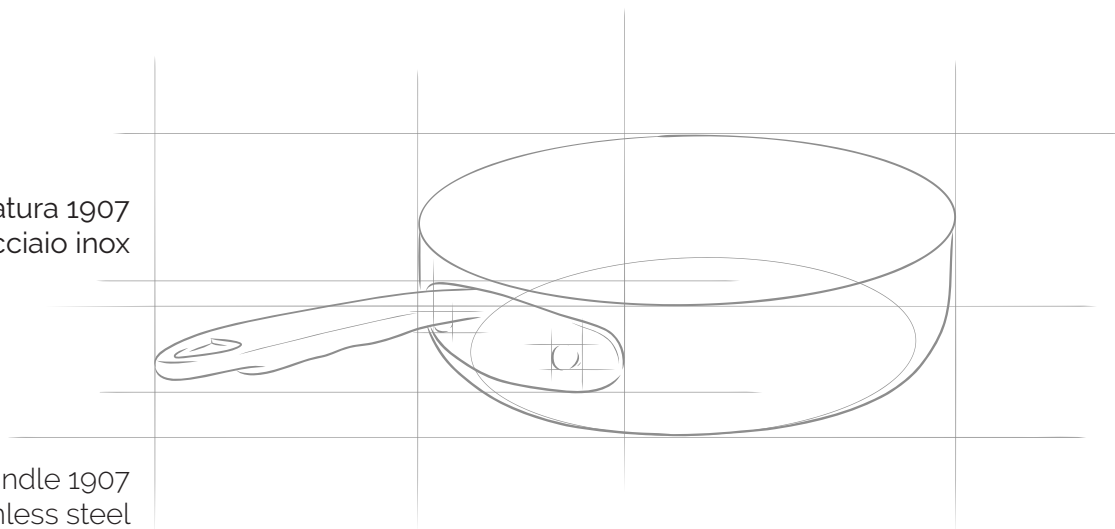

**CASSERUOLINO ALTO
CON UN MANICO INOX**

ONE-HANDLE HIGH LITTLE SAUCEPAN

Code	Ø cm	H cm	lt	IVA esc.
ALCX10512S	12	7	0.79	30.30 €
ALCX10514S	14	7.5	1.15	32.24 €



**CASSERUOLINO BASSO
CON UN MANICO INOX**

ONE-HANDLE LOW LITTLE CASSEROLE PAN

Code	Ø cm	H cm	lt	IVA esc.
ALCX10712S	12	4,5	0,51	29,16 €
ALCX10714S	14	5,5	0,85	30,30 €



**TEGAMINO
CON DUE MANIGLIE INOX**

TWO-HANDLE LITTLE OMELETTE PAN

Code	Ø cm	H cm	IVA esc.
ALCX11012S	12	3,5	37,99 €
ALCX11014S	14	4	38,74 €



PADELLINO CON UN MANICO INOX

LITTLE PAN

Code	Ø cm	H cm	IVA esc.
ALCX11112S	12	3,5	29,16 €
ALCX11114S	14	4	29,92 €

RAME COPPER



No induzione
No induction



Ideale per monoporzioni in forno
Ideal for single portions in the oven



Manicatura in ottone
Brass handle

Compatibile con inserti in
porcellana, previa verifica delle
dimensioni.

Compatible with porcelain
inserts, provided the dimensions
are verified.

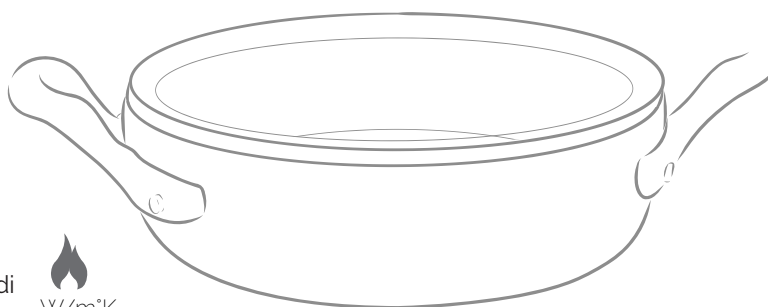

Capacità di
condurre il calore $\frac{W}{m^{\circ}K}$
Heat conductivity **392**

Interno in stagno
Interior lined with tin



CASSERUOLINO ALTO
CON UN MANICO IN OTTONE

COPPER ONE-HANDLE HIGH LITTLE SAUCEPAN

Code	Ø cm	H cm	lt	IVA esc.
ALCU105F10	10	6,5	0,51	114,24 €
ALCU105F12	12	7,5	0,85	130,22 €
ALCU105F14	14	8,5	1,31	141,56 €



CASSERUOLINO BASSO
CON UN MANICO IN OTTONE

COPPER ONE-HANDLE
LOW LITTLE CASSEROLE PAN

Code	Ø cm	H cm	lt	IVA esc.
ALCU107F10	10	4	0,31	105,67 €
ALCU107F12	12	4,5	0,51	121,74 €
ALCU107F14	14	5,5	0,85	133,08 €



TEGAMINO
CON DUE MANIGLIE IN OTTONE

COPPER TWO-HANDLE LITTLE OMELETTE PAN

Code	Ø cm	H cm	IVA esc.
ALCM110M14	14	4	114,86 €



PADELLINO
CON UN MANICO IN OTTONE

COPPER LITTLE PAN

Code	Ø cm	H cm	IVA esc.
ALCM111M14	14	3,5	114,86 €



CASSERUOLINO BASSO
CON UN MANICO IN OTTONE

COPPER ONE-HANDLE LOW LITTLE CASSEROLE PAN

Code	Ø cm	H cm	lt	IVA esc.
COCU104M07	7	3.5	0.13	66,00 €



CASSERUOLINO BASSO
CON UN MANICO IN OTTONE FUSO

COPPER ONE-HANDLE
LOW LITTLE CASSEROLE PAN

Code	Ø cm	H cm	lt	IVA esc.
ALCU107F04	4	2.5	0.03	64,71 €



PADELLINO SVASATO
CON UN MANICO IN OTTONE

COPPER LITTLE PAN

Code	Ø cm	H cm	IVA esc.
COCU111M10	10	2.7	72,64 €

Agnelli
SINCE 1907

LINEA 1932

1932 COLLECTION

INSERTI IN PORCELLANA
PORCELAIN INSERTS



Ideale per monoporzioni in forno
Ideal for single portions in the oven

Grazie alla porcellana, le pietanze restano calde più a lungo, permettendo di servire direttamente in padella senza comprometterne la pulizia.

Thanks to porcelain, food stays warm longer, allowing you to serve directly from the pan without compromising cleanliness.

Porcellana da forno
resistente ad alte
temperature, fino a 500°

Oven-safe porcelain
resistant to high
temperatures, up to 500°

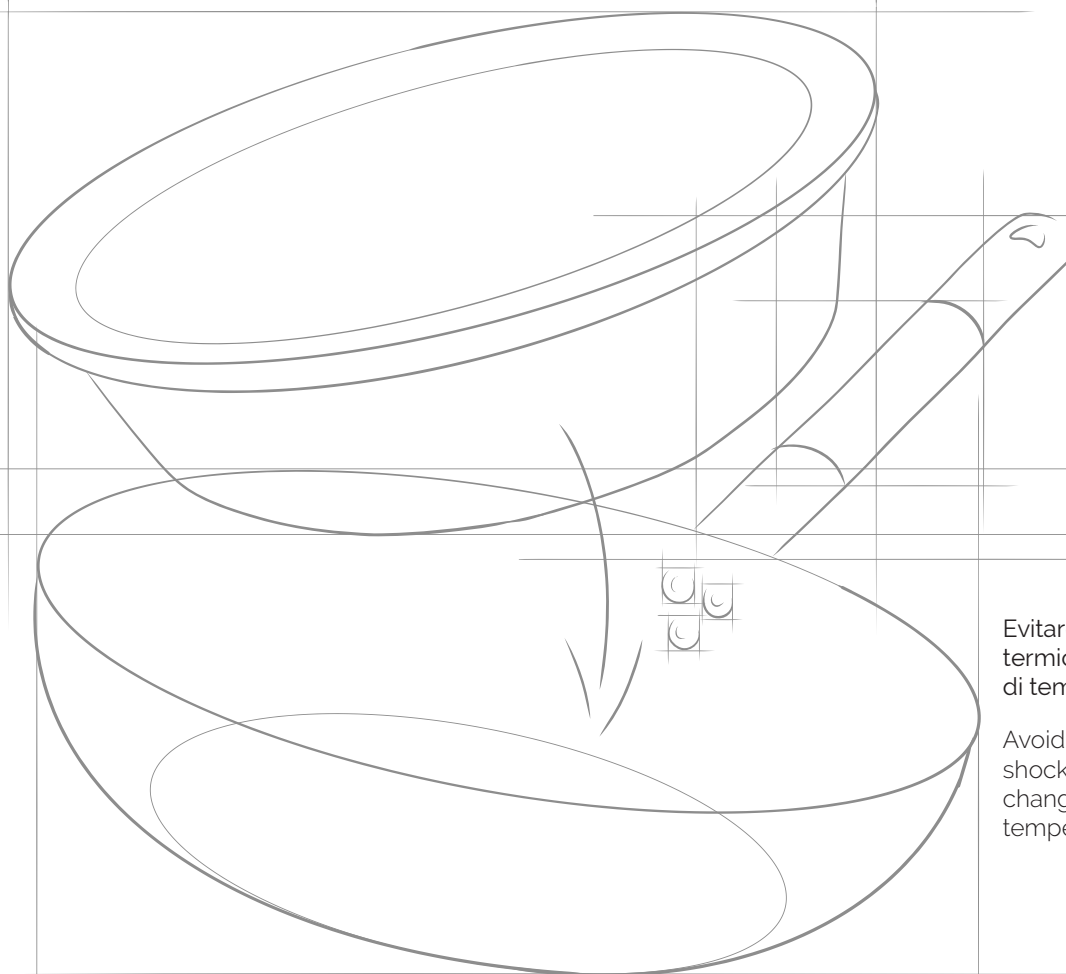

Evitare shock
termici o sbalzi
di temperatura

Avoid thermal
shock or sudden
changes in
temperature

La padella impiegata per mantecare o saltare la pasta è immediatamente pronta per essere riutilizzata con una nuova porzione.

"The pan used to sauté or finish the pasta is instantly ready to be reused for the next serving.



PER ART. 110 E 111

FOR ART. 110 AND 111

DA CM 24

OF 24 CM

Code	Ø cm	H cm	UDV	IVA esc.
COCE11024WHT	24,8	5,1	6	19,17 €

PER ART. 110 E 111

FOR ART. 110 AND 111

DA CM 28

OF 28 CM

Code	Ø cm	H cm	UDV	IVA esc.
COCE11028WHT	28,8	5,3	6	26,84 €



PER ART. ALUM111BM20
FOR ART. ALUM111BM20

La preparazione viene servita direttamente in tavola utilizzando la padella mantecare Alu-Inox, un pezzo iconico che unisce funzionalità e design raffinato.

The preparation is served directly at the table using the Alu-Inox sauté pan, an iconic piece that combines functionality with refined design.

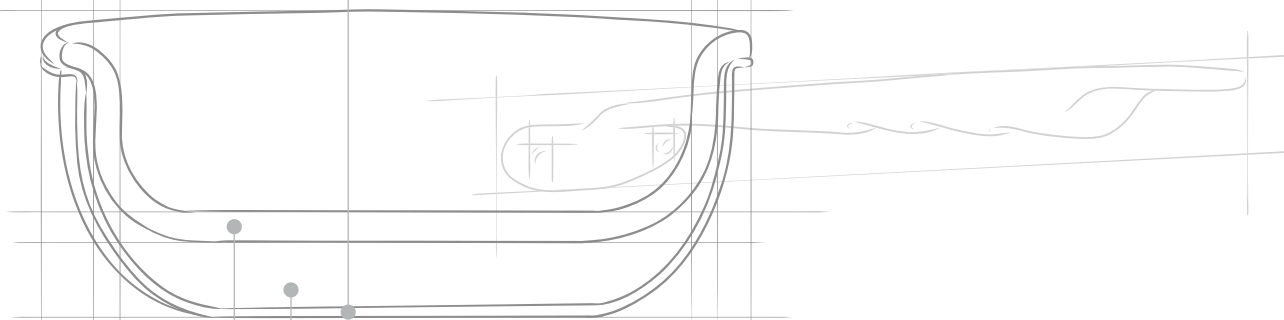

Inserto in porcellana con profondità ridotta rispetto al corpo padella, progettato per la cottura a bagnomaria. Lo spazio sottostante consente l'inserimento di liquido termovettore, generando calore indiretto e uniforme, ideale per lavorazioni delicate come scioglimento di cioccolato, emulsioni, salse e creme.

Porcelain insert with reduced depth compared to the pan body, designed for bain-marie cooking. The gap underneath allows the addition of a heat-transfer liquid, generating indirect and uniform heat—ideal for delicate preparations such as melting chocolate, emulsions, sauces, and creams.



NEW

Code	Ø cm	H cm	UDV	IVA esc.
COCE111BM20WHT	21,6	6,1	6	16,80 €



PER ART. 110 E 111

FOR ART. 110 AND 111

DA CM 12

OF 12 CM

Code	Ø cm	H cm	UDV	IVA esc.
COCE11012WHT	13	4	6	5,81 €

DA CM 14

OF 14 CM

Code	Ø cm	H cm	UDV	IVA esc.
COCE11014WHT	15	4	6	6,65 €

DA CM 16

OF 16 CM

Code	Ø cm	H cm	UDV	IVA esc.
COCE11016WHT	16,5	4	6	8,64 €

DA CM 20

OF 20 CM

Code	Ø cm	H cm	UDV	IVA esc.
COCE11020WHT	20,5	5	6	14,38 €



PER ART. 106 E 107 FOR ART. 106 AND 107
DA CM 10 OF 10 CM

Code	Ø cm	H cm	UDV	IVA esc.
COCE10610WHT	8,5	4,5	6	4,03 €



PER ART. 104 E 105 FOR ART. 104 AND 105
DA CM 10 OF 10 CM

Code	Ø cm	H cm	UDV	IVA esc.
COCE10410WHT	8,5	6,5	6	5,26 €

RIFLESSI D'ACQUA

PER RACCONTARE IL MARE

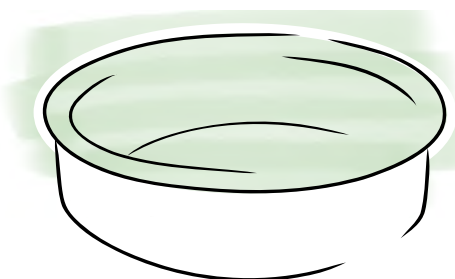
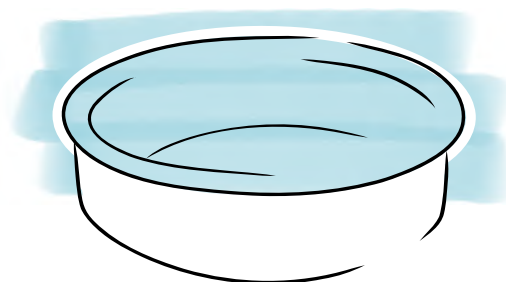

ISPIRATA ALLA NATURA

DONA FRESCHEZZA ED ELEGANZA.

NEUTRA E MATERICA

VALORIZZA I COLORI ACCESI

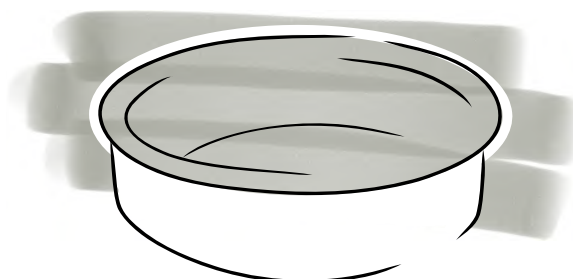

NEW

BLU - BLUE

PER ART. 110 E 111

FOR ART. 110 AND 111

DA CM 16

OF 16 CM

Code	Ø cm	H cm	UDV	IVA esc.
COCE11016BLU	16,5	4	6	10,08 €

DA CM 20

OF 20 CM

Code	Ø cm	H cm	UDV	IVA esc.
COCE11020BLU	20,5	5	6	17,14 €

PER ART. 110 E 111

FOR ART. 110 AND 111

DA CM 24

OF 24 CM

Code	Ø cm	H cm	UDV	IVA esc.
COCE11024BLU	24,8	5,1	6	21,89 €

PER ART. 110 E 111

FOR ART. 110 AND 111

DA CM 28

OF 28 CM

Code	Ø cm	H cm	UDV	IVA esc.
COCE11028BLU	28,8	5,3	6	31,85 €

NEW

VERDE - GREEN

PER ART. 110 E 111 FOR ART. 110 AND 111

DA CM 16 OF 16 CM

Code	Ø cm	H cm	UDV	IVA esc.
COCE11016GRN	16,5	4	6	10,08 €

DA CM 20 OF 20 CM

Code	Ø cm	H cm	UDV	IVA esc.
COCE11020GRN	20,5	5	6	17,14 €

PER ART. 110 E 111 FOR ART. 110 AND 111

DA CM 24 OF 24 CM

Code	Ø cm	H cm	UDV	IVA esc.
COCE11024GRN	24,8	5,1	6	21,89 €

PER ART. 110 E 111 FOR ART. 110 AND 111

DA CM 28 OF 28 CM

Code	Ø cm	H cm	UDV	IVA esc.
COCE11028GRN	28,8	5,3	6	31,85 €



NEW

GRIGIO - GREY

PER ART. 110 E 111 FOR ART. 110 AND 111

DA CM 16 OF 16 CM

Code	Ø cm	H cm	UDV	IVA esc.
COCE11016GRY	16,5	4	6	10,08 €

DA CM 20 OF 20 CM

Code	Ø cm	H cm	UDV	IVA esc.
COCE11020GRY	20,5	5	6	17,14 €

PER ART. 110 E 111 FOR ART. 110 AND 111

DA CM 24 OF 24 CM

Code	Ø cm	H cm	UDV	IVA esc.
COCE11024GRY	24,8	5,1	6	21,89 €

PER ART. 110 E 111 FOR ART. 110 AND 111

DA CM 28 OF 28 CM

Code	Ø cm	H cm	UDV	IVA esc.
COCE11028GRY	28,8	5,3	6	31,85 €



VASSOIO FRUTTI DI MARE

SEAFOOD TRAY, ALUMINUM



Code	Ø cm	H cm	IVA esc.
ALMA15824	24	4.5	12,81 €
ALMA15830	30	5.5	20,18 €
ALMA15836	36	5.5	22,11 €
ALMA15850	50	7.5	44,57 €



VASSOIO FRUTTI DI MARE IN RAME

SEAFOOD TRAY, COPPER



Code	Ø cm	H cm	IVA esc.
COCU15824	24	4.5	107,25 €
COCU15836	36	5.5	181,50 €



SUPPORTO ACCIAIO CROMATO

CHROMED STEEL HOLDER

Code	Ø cm	H cm	IVA esc.
COIX158B	19-28	20	€ 11,55
COIX158C	30-40	20	€ 23,31



MINIPIATTO MARTELLATO IN 3PLY

3PLY MINI-PLATE

Code	Ø cm	H cm	Ma-ster	Inner	IVA esc.
ALUMPLATEM05	8,8	1,9	12	1	€ 15,44
ALUMPLATEM07	11,8	2,3	12	1	€ 19,10
ALUMPLATEM09	14	2,4	12	1	€ 23,50



MINI ALZATA PER MINIPIATTO MARTELLATO

MINI STAND FOR HAMMERED MINI-PLATE

Code	Ø cm	H cm	Master	Inner	IVA esc.
COIX158MS1	5,4-7,4	4	12	1	€ 5,00
COIX158MS2	7,4-9	4	12	1	€ 6,50

SET COMPLETO DI 3 MINIPIATTINI IN ALU-INOX 3-PLY MARTELLATO E 2 ALZATINE

COMPLETE SET OF 3 HAMMERED ALU-INOX
3-PLY MINI PLATES AND 2 STANDS



Il set comprende:

- N. 1 mini piattino in 3ply Ø 8,8cm
ALUMPLATE05
- N. 1 mini piattino in 3ply Ø 11,8cm
ALUMPLATE07
- N. 1 mini piattino in 3ply Ø 14cm
ALUMPLATE09
- N. 1 MINI ALZATINA COIX158MS1
- N. 1 MINI ALZATINA COIX158MS2

The set includes:

- N. 1 mini-plate in 3ply Ø 8,8cm
ALUMPLATE05
- N. 1 mini-plate in 3ply Ø 11,8cm
ALUMPLATE07
- N. 1 mini-plate in 3ply Ø 14cm
ALUMPLATE09
- N. 1 MINI STAND COIX158MS1
- N. 1 MINI STAND COIX158MS2

Code	IVA esc.
ALUM158KIT	€ 70,00



SECCHIELLO CHAMPAGNE PESANTE LISCIO ANODIZZATO

CHAMPAGNE BUCKET, HEAVY
ALU ANODIZED, SMOOTH

Code	Ø cm	H cm	IVA esc.
FAMA80OR*	20	18	€ 53,87
FAMA80AR**	20	18	€ 51,11

* ORO - GOLD

** ARGENTO - SILVER



CHAFING DISH ELEGANCE CON COPERCHIO A SCOMPARSA

ROLL TOP CHAFING DISH GEL FIRE

Code	cm	H cm	IVA esc.
COIX3100RE64	64,2x47	42	€ 375,00

MISURE BACINELLA INTERNA: CM 53X32,5, H CM 6,5



PIASTRA ELETTRICA 300 WATTS 220V

ELECTRIC PLATE 300 WATTS 220V

Code	pz	IVA esc.
COIX3177PE	1	€ 95,00



CHAFING DISH
CON COPERCHIO MOBILE

LIFT TOP CHAFING DISH

Code	cm	H cm	IVA esc.
COIX3131	56x35,5	31	127,50 €

MISURE BACINELLA INTERNA: CM 53x32,5, H CM 6,5



CHAFING DISH
CON MEZZO COPERCHIO ROTANTE

ROLL HALF TOP CHAFING DISH

Code	cm	H cm	IVA esc.
COIX3177RS35	64x35	40	€ 232,00

MISURE BACINELLA INTERNA: CM 53x32,5, H CM 6,5



COMBUSTIBILE LIQUIDO PER CHAFING
DISHES A FIAMMA REGOLABILE
CONF. 24 PZ 175 GR./CAD.

FUEL FOR CHAFING DISHES

Code	Ø cm	H cm	* IVA esc.
4HR	8,6	4,4	€ 60,06

* PREZZO A CONFEZIONE

Agnelli
SINCE 1907

GHISA SMALTATA
ENAMELLED CAST IRON



per tutti i piani di cottura
for all hobs

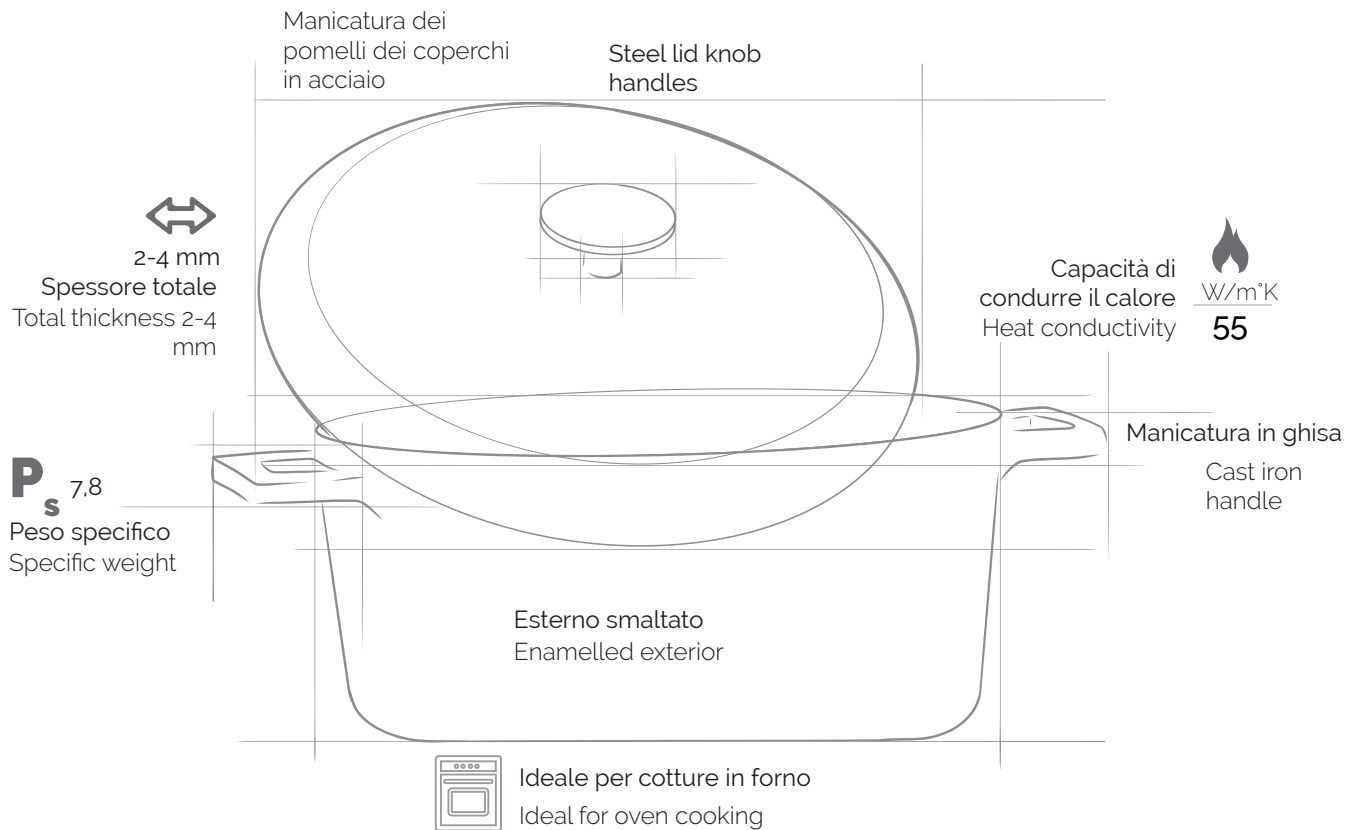

CASSERUOLA CON DUE MANIGLIE IN GHISA
CON COPERCHIO

ROUND SAUCEPOT

Code	Ø cm	H cm	lt	IVA esc.
COGHSRP10420O	20	10	2,6	€ 159,39
COGHSRP10424O	24	11	4,5	€ 205,59
COGHSRP10428O	28	12	6,7	€ 242,55
COGHSRP10432O	32	12	10	€ 293,37



CASSERUOLA BASSACON DUE MANIGLIE IN GHISA CON COPERCHIO

ROUND LOW SAUCEPOT

Code	Ø cm	H cm	lt	IVA esc.
COGHSRP106240	24	6	2.4	€ 168,63
COGHSRP106280	28	6	3.4	€ 210,21

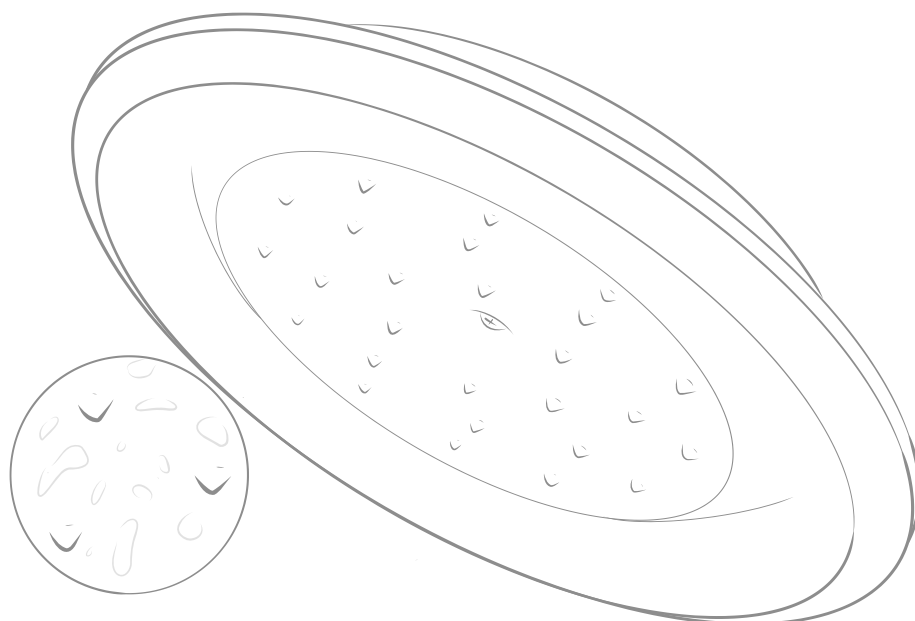

Il coperchio è dotato di rilievi interni che favoriscono la condensazione e ridistribuiscono l'acqua evaporata, mantenendo i cibi umidi e saporiti. È anche possibile posizionare del ghiaccio sulla parte superiore per intensificare il processo di condensazione.

The lid features inner bumps that promote condensation and redistribute evaporated water, keeping food moist and flavorful. Placing ice on top of the lid further enhances the condensation process.



CASSERUOLA OVALE CON DUE MANIGLIE IN GHISA CON COPERCHIO

OVAL SAUCEPOT

Code	Ø cm	H cm	lt	IVA esc.
COGHSOP126250	25x20	10	3.3	€ 182,49
COGHSOP126290	29x22	14	4.8	€ 212,52



**MINI CASSERUOLA CON DUE MANIGLIE IN
GHISA CON COPERCHIO**

ROUND MINI SAUCEPOT

Code	Ø cm	H cm	lt	IVA esc.
COGHSRP10410O	10	6	0,36	€ 90,09
COGHSRP10414O	14	6	0,8	€ 113,19



**MINI CASSERUOLA OVALE CON
DUE MANIGLIE IN GHISA CON COPERCHIO**

OVAL MINI SAUCEPOT

Code	Ø cm	H cm	lt	IVA esc.
COGHSOP12612O	12x9	6	0,4	€ 92,40



COPERCHIO GHISA

ROUND LID (ADDITIONAL)

Code	Ø cm	IVA esc.
COGHSRL12910O	10	€ 23,16



COPERCHIO OVALE GHISA

OVAL LID (ADDITIONAL)

Code	Ø cm	IVA esc.
COGHSOL12912O	12x9	€ 23,16



VASSOIO IN LEGNO PER MINI CASSERUOLA OVALE

WOODEN TRAY FOR OVAL POT

Code	cm	IVA esc.
COGHSWT12090	12x9	€ 30,34



VASSOIO IN LEGNO PER MINI CASSERUOLA TONDA

WOODEN TRAY FOR ROUND POT

Code	cm	IVA esc.
COGHSWT10000	10	€ 26,26



**GRIGLIA BICOLORE
CON UN MANICO E MANIGLIA IN GHISA**

CAST IRON BI-COLOUR GRILL PAN CAST
IRON HANDLE

Code	cm	H cm	IVA esc.
COGHSGP26260O	26x26	4.1	€ 129,36
COGHSGP26320O	26x32	5.7	€ 140,91



**GRIGLIA TONDA
CON DUE MANIGLIE IN GHISA**

CAST IRON GRILL TRAY ROUND CAST
IRON SHORT HANDLE

Code	Ø cm	H cm	IVA esc.
COGHSET30000M	30	4.1	€ 103,95



GRIGLIA CON DUE MANIGLIE IN GHISA

CAST IRON GRILL TRAY CAST IRON SHORT HANDLE

Code	cm	H cm	IVA esc.
COGHSET26260M	26x26	4	€ 99,33
COGHSET26320M	26x32	4	€ 106,26



**MINI PADELLA TONDA
CON UN MANICO IN GHISA**

MINI ROUND PAN WITH A CAST IRON HANDLE

Code	Ø cm	H cm	IVA esc.
COGHSMG16000M	16	4,4	€ 60,06



MINI TEGAME CON DUE MANIGLIE IN GHISA

MINI PAN WITH TWO CAST IRON HANDLES

Code	Ø cm	H cm	IVA esc.
COGHSMP12000M	12	3	€ 50,82
COGHSMP16000M	16	3	€ 57,75
COGHSMP20000M	20	3	€ 62,37



MINI GRIGLIA CON UN MANICO IN GHISA

CAST IRON MINI GRILL PAN CAST
IRON CORNER HANDLE

Code	cm	H cm	IVA esc.
COGHSMG16160M	16X16	4,2	€ 60,06



CASSERUOLA ALTA CON DUE MANIGLIE
IN RAME E COPERCHIO

SAUCEPOT, 2 HANDLES

Code	Ø cm	H cm	lt	IVA esc.
COOL104C20	20	10	2,3	€ 190,19
COOL104C22	22	10	2,8	€ 210,88
COOL104C24	24	12	3,4	€ 227,42
COOL104C26	26	12,2	4	€ 253,62
COOL104C28	28	12	5,8	€ 334,66
COOL104C30	30	12	6,7	€ 380,31



**PIETRA QUADRATA
CON SUPPORTO IN ACCIAIO INOX 18/10 E
BASAMENTO IN LEGNO**

SQUARE STONE PLATE
WITH STAINLESS STEEL 18/10 HOLDER AND
WOOD BASE

Code	cm	H cm	IVA esc.
COLA100/LS	25x25	4.5	€ 148,23



**PIETRA RETTANGOLARE
CON SUPPORTO IN ACCIAIO INOX 18/10 E
BASAMENTO IN LEGNO**

RECTANGULAR STONE PLATE
WITH STAINLESS STEEL 18/10 HOLDER AND
WOOD BASE

Code	cm	H cm	IVA esc.
COLA200/LM	25x30	4.5	€ 150,79



**PIETRA QUADRATA
CON SUPPORTO IN ACCIAIO INOX 18/10**

SQUARE STONE PLATE
WITH STAINLESS STEEL 18/10 HOLDER

Code	cm	H cm	IVA esc.
COLA100/S	25x25	2.8	€ 56,41



**PIETRA RETTANGOLARE A SPIGOLI
ARROTONDATI CON SUPPORTO IN ACCIAIO
INOX 18/10 E BASAMENTO IN LEGNO**

RECTANGULAR STONE ROUNDED CORNERS PLATE WITH STAINLESS STEEL 18/10 HOLDER AND WOOD BASE

Code	cm	H cm	IVA esc.
COLA250/LR	25x35	4,5	€ 168,45



**PIETRA RETTANGOLARE
CON SUPPORTO IN ACCIAIO INOX
18/10 E BASAMENTO IN LEGNO**

RECTANGULAR STONE PLATE WITH STAINLESS STEEL 18/10 HOLDER AND WOOD BASE

Code	cm	H cm	IVA esc.
COLA300/LL	29x40	4,5	€ 180,71



**PIETRA RETTANGOLARE
CON SUPPORTO IN ACCIAIO INOX
18/10**

RECTANGULAR STONE PLATE WITH STAINLESS STEEL 18/10 HOLDER

Code	cm	H cm	IVA esc.
COLA200/M	25x30	2,8	€ 50,13



**PIETRA RETTANGOLARE A SPIGOLI
ARROTONDATI CON SUPPORTO IN ACCIAIO
INOX 18/10**

RECTANGULAR STONE ROUNDED CORNERS PLATE
WITH STAINLESS STEEL 18/10 HOLDER

Code	cm	H cm	IVA esc.
COLA250/R	25x35	2,8	€ 72,50



**PIETRA RETTANGOLARE
CON SUPPORTO IN ACCIAIO INOX 18/10**

RECTANGULAR STONE PLATE
WITH STAINLESS STEEL 18/10 HOLDER

Code	cm	H cm	IVA esc.
COLA300/L	29x40	2,5	€ 77,76

ALLUMINIO
ALUMINUM

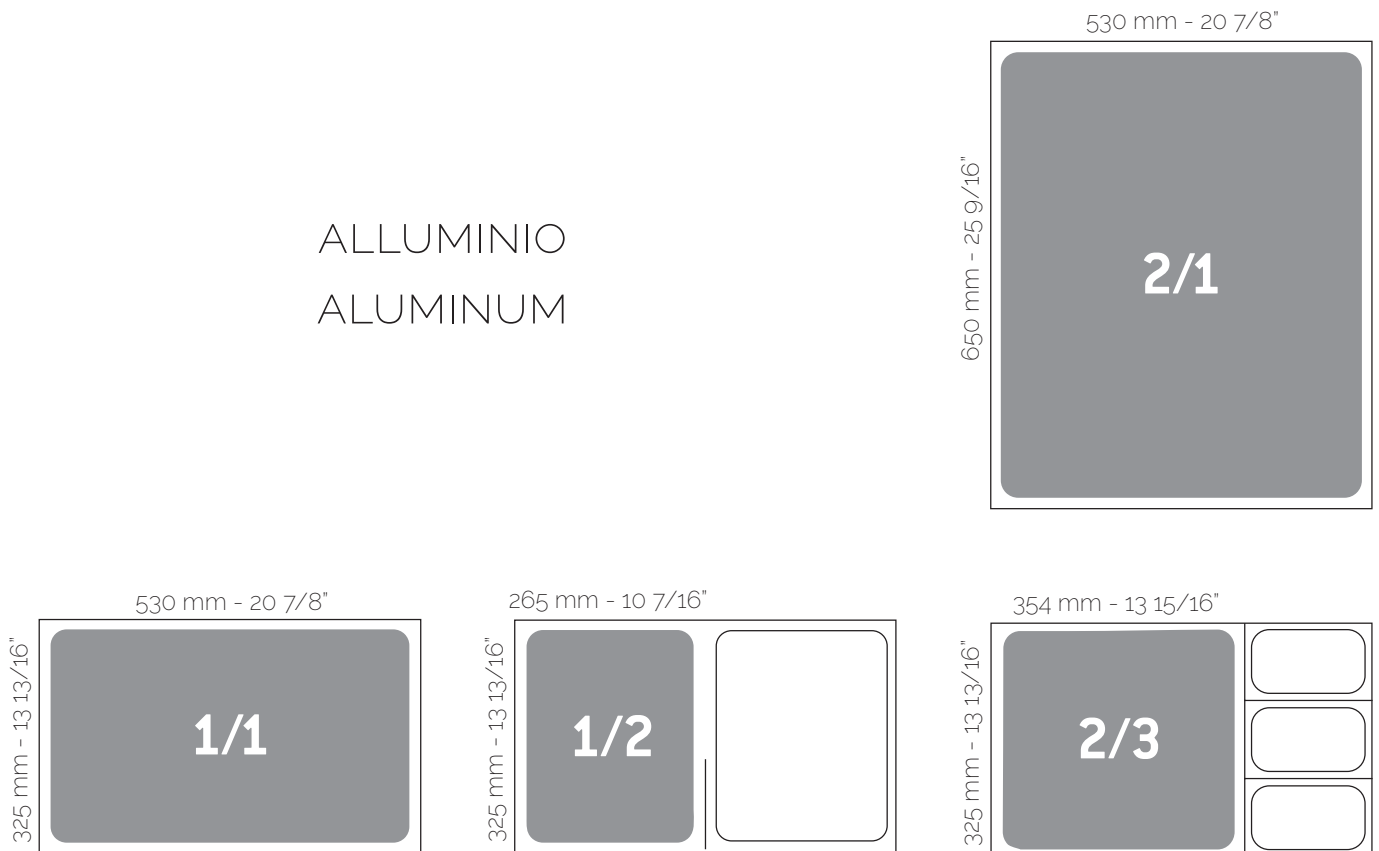

GRIGLIA GASTRONORM 2/3 PER GRIGLIARE
IN LEGA 6082 RIVESTITA CON ANTIADERENTE

GASTRONORM GRILL (FOR GRILLING), AL-
LOY 6082, NON-STICK COATING

Code	cm	H cm	IVA esc.
COAL182G-2/3	35,4x32,5	2	211,07 €



**GRIGLIA GASTRONORM 1/1 PER GRIGLIARE
IN FUSIONE RIVESTITA CON ANTIADERENTE**

GASTRONORM GRILL (FOR GRILLING),
FUSION 3003, NON-STICK COATING

Code	cm	H cm	IVA esc.
COAL182G-1/1	53x32.5	2	161,32 €

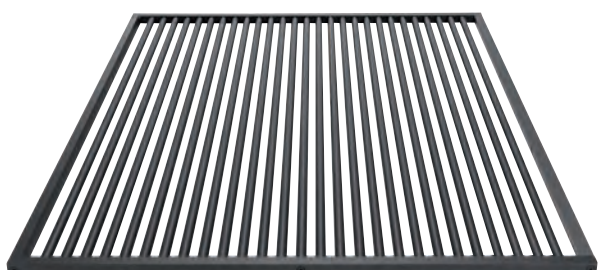

**GRIGLIA GASTRONORM 2/1 PER GRIGLIARE
IN LEGA 6082 RIVESTITA CON ANTIADERENTE**

GASTRONORM GRILL (FOR GRILLING),
ALLOY 6082, NON-STICK COATING

Code	cm	H cm	IVA esc.
COAL182G-2/1	65x53	2	281,41 €

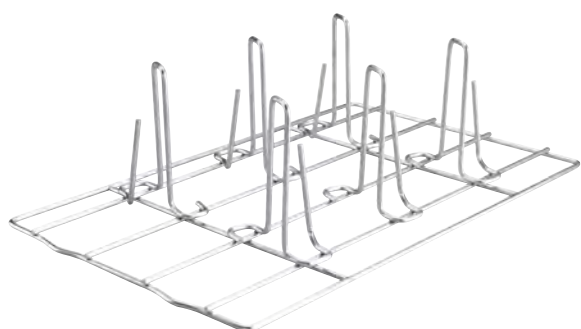

**ACCIAIO INOX
STAINLESS STEEL**

**GRIGLIA GASTRONORM 1/1
PER COTTURA VERTICALE DEL POLLO**

GASTRONORM RACK TO GRILL CHICKEN IN VERTICAL

COIX182C-1/1 8 POSTI	COIX182C6-1/1 6 POSTI
-------------------------	--------------------------

Code	cm	H cm	IVA esc.
COIX182C-1/1	53x32.5	16	84,15 €
COIX182C6-1/1	53x32.5	16	78,18 €

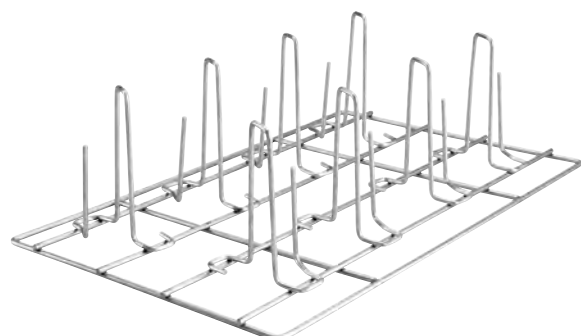



TEGLIA GASTRONORM 1/1 IN LEGA 3003

GASTRONORM CONTAINER

Code	cm	H cm	IVA esc.
ALMA18220	53x32,5	2	24,02 €
ALMA18240	53x32,5	4	26,57 €
ALMA18265	53x32,5	6,5	45,29 €



TEGLIA GASTRONORM 1/1 RIVESTITA INTERNO/ESTERNO CON ANTIADERENTE

GASTRONORM BAKING SHEET,
NON-STICK COATING INSIDE AND OUTSIDE

Code	cm	H cm	IVA esc.
ALSA182SS20	53x32,5	2	90,44 €
ALSA182SS40	53x32,5	4	100,90 €
ALSA182SS60	53x32,5	6	109,91 €



TEGLIA GASTRONORM 1/1 IN LEGA 3003 MICROFORATA (Ø FORO 2 MM)

GASTRONORM BAKING SHEET,
MICROPERFORATED, ALLOY 3003

Code	cm	H cm	IVA esc.
COAL182MF-1/1	53x32,5	2	50,42 €

TEGLIA GASTRONORM 1/1 IN LEGA 3003 RIVESTITA INTERNAMENTE CON ANTIADERENTE



GASTRONORM BAKING SHEET,
ALLOY 3003, NON-STICK COATING

Code	cm	H cm	IVA esc.
ALSA182S20	53x32.5	2	59.11 €
ALSA182S40	53x32.5	4	69.60 €
ALSA182S65	53x32.5	6.5	77.63 €

TEGLIA GASTRONORM 1/2 RIVESTITA INTERNO/ESTERNO CON ANTIADERENTE



GASTRONORM BAKING SHEET,
NON-STICK COATING INSIDE AND OUTSIDE

Code	cm	H cm	IVA esc.
ALSA282SS20	26,5x32,5	2	66.77 €
ALSA282SS40	26,5x32,5	4	84.94 €
ALSA282SS60	26,5x32,5	6	87.79 €

TEGLIA GASTRONORM 1/1 IN LEGA 3003 MICROFORATA (Ø FORO 2 MM) CON BINARIO LATO CORTO

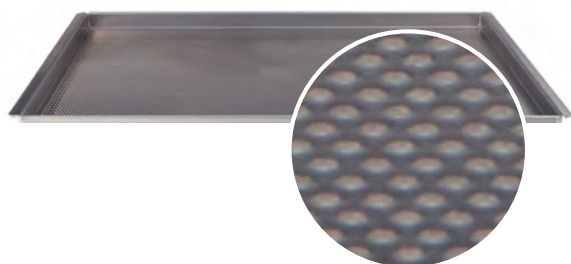

GASTRONORM BAKING SHEET,
MICROPERFORATED, ALLOY 3003,
WITH GUIDE GROOVES ON THE SHORT SIDES

Code	cm	H cm	IVA esc.
COAL182MFB-1/1	53x32.5	2	48.60 €

TEGLIA GASTRONORM 1/1 MICROFORATA (Ø FORO 2 MM) IN LEGA 3003 RIVESTITA CON ANTIADERENTE

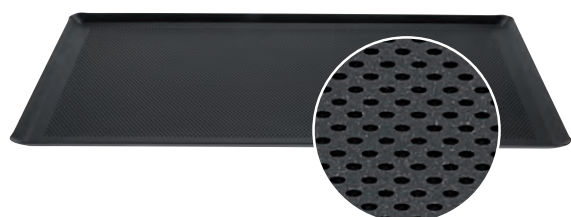

PERFORATED G/N BAKING SHEETS,
ALLOY 3003, NON-STICK COATING

Code	cm	H cm	IVA esc.
COSA182MFS-1/1	53x32.5	2	81.93 €

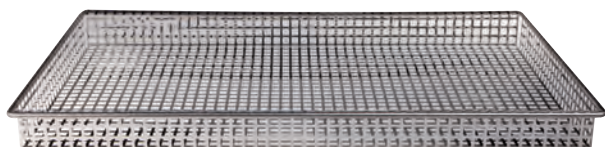

TEGLIA PER FRITTURA 1/1 ACCIAIO INOX

PAN FOR FRIED PRODUCTS IN STAINLESS STEEL

Code	cm	H cm	IVA esc.
COIX182P-1/1	53,5x32,5	4	100,79 €



TEGLIA MICROFORATA 1/1 PER BAGUETTES IN ALLUMINIO

BAKING SHEET WITH MOULDS
FOR FRENCH LOAVES, MICROPERFORATED, ALU-
MINUM

Code	cm	H cm	IVA esc.
COAL49B53	53x32,5	6	81,26 €

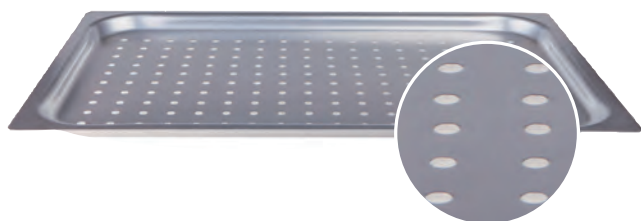

TEGLIA GASTRONORM 1/1 IN LEGA 3003 FORATA

PERFORATED GASTRONORM BAKING SHEET,
ALLOY 3003

Code	cm	H cm	IVA esc.
ALMA182F20	53x32,5	2	45,05 €



**TEGLIA GASTRONORM 1/1
CON 6 STAMPI Ø 12,5**

GASTRONORM MAT WITH MOULDS Ø 12,5

Code	cm	H cm	IVA esc.
COAL18306	53x32,5	1,8	59,35 €



**TEGLIA GASTRONORM 1/1
CON 6 STAMPI Ø 12,5
RIVESTITA CON ANTIADERENTE**

GASTRONORM MAT WITH MOULDS Ø 12,5

Code	cm	H cm	IVA esc.
COSA183/S06	53x32,5	2	104,31 €



**TEGLIA GASTRONORM 1/1 CON
8 STAMPI Ø 11 RIVESTITA CON
ANTIADERENTE**

GASTRONORM MAT
WITH MOULDS Ø 11 WITH NON-STICK COATING

Code	cm	H cm	IVA esc.
COSA183/SS08	53x32,5	2	97,66 €



**TEGLIA GASTRONORM 2/1
CON 12 STAMPI Ø 12,5**

GASTRONORM MAT WITH MOULDS Ø 12,5

Code	cm	H cm	IVA esc.
COAL18312	53x65	1,8	98,07 €



**TEGLIA GASTRONORM 2/1
CON 12 STAMPI Ø 12,5
RIVESTITA CON ANTIADERENTE**

GASTRONORM MAT WITH MOULDS Ø 12,5
WITH NON-STICK COATING

Code	cm	H cm	IVA esc.
COSA183/S12	53x65	2	157,15 €



BACINELLA GASTRONORM 1/1 ALLUMINIO

ALUMINIUM GN 1/1 PAN

SU ORDINAZIONE

Code	cm	H cm	IVA esc.
ALSA182GHA20	53x32,5	2	101,95 €
ALSA182GHA65	53x32,5	6,5	130,70 €
ALSA182GHA100	53x32,5	10	152,51 €



**BACINELLA GASTRONORM 1/1
ALLUMINIO RIVESTITO CON ANTIADERENTE
NERO**

ALUMINIUM GN 1/1 PAN WITH NON-STICK

COATING

Code	cm	H cm	IVA esc.
ALSA182C/S20	53x32,5	2	64,24 €



**BACINELLA GASTRONORM 1/1 ALLUMINIO
RIVESTITO CON ANTIADERENTE NERO**

ALUMINIUM GN 1/1 PAN WITH NON-STICK
COATING

Code	cm	H cm	IVA esc.
ALSA182C/S100	53x32,5	10	90,99 €



**BACINELLA GASTRONORM 1/1 ALLUMINIO
RIVESTITO CON ANTIADERENTE NERO**

ALUMINIUM GN 1/1 PAN WITH NON-STICK COATING

Code	cm	H cm	IVA esc.
ALSA182C/S65	53x32.5	6.5	86,96 €



BACINELLA GASTRONORM 1/1 ALLUMINIO

ALUMINIUM GN 1/1 PAN

Code	cm	H cm	IVA esc.
ALMA182C65	53x32.5	6.5	41.23 €



BACINELLA GASTRONORM 1/1 ALLUMINIO

ALUMINIUM GN 1/1 PAN

Code	cm	H cm	IVA esc.
ALMA182C20	53x32.5	2	35,27 €



**BACINELLA GASTRONORM 1/1
ALLUMINIO**

ALUMINIUM GN 1/1 PAN

Code	cm	H cm	IVA esc.
ALMA182C100	53x32.5	10	45,23 €

ACCIAIO
INOX
STAINLESS
STEEL

- Disegno esclusivo Agnelli conforme EN 631
 - Acciaio inox SS304 con lucidatura elettrolitica
 - Massima resistenza alla corrosione
 - Spessore superiore alla media di mercato
 - Superati i test di resistenza alla nebbia salina
-
- Exclusive Agnelli design compliant with EN 631
 - Stainless steel SS304 with electrolytic polishing
 - Maximum corrosion resistance
 - Thickness above market average
 - Passed salt spray resistance tests

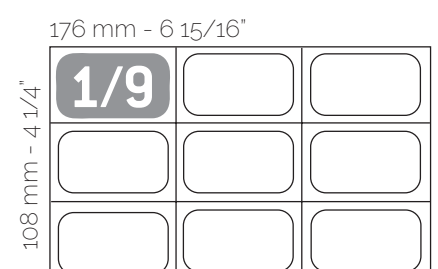
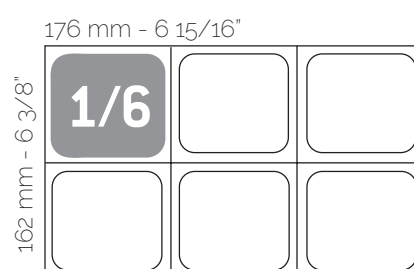
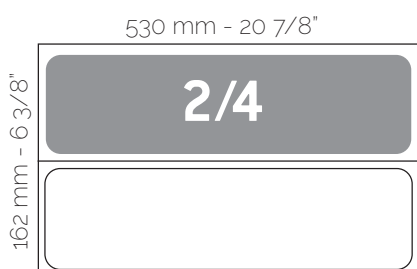
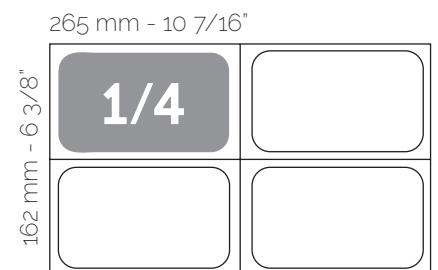
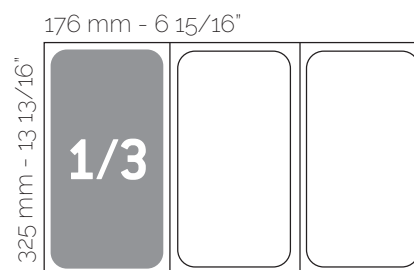
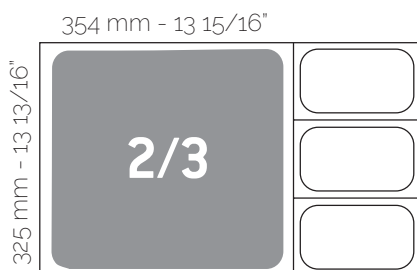
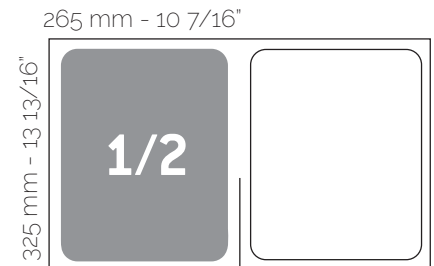
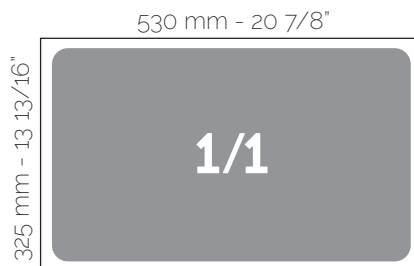
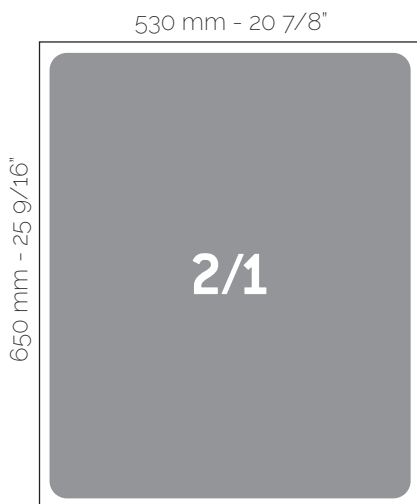

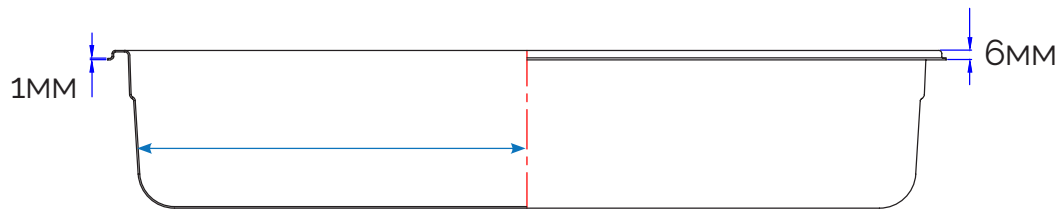

BACINELLA INOX GN 2/1
STAINLESS STEEL PAN GN 2/1

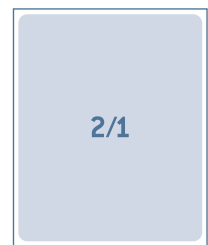

CODE	DESCRIZIONE - DESCRIPTION	UDV	IVA esc.
COIXGNP21020	GN 2/1 65x53 h 2 cm	6	€ 48,00
COIXGNP21040	GN 2/1 65x53 h 4 cm	6	€ 52,33
COIXGNP21065	GN 2/1 65x53 h 6,5 cm	6	€ 59,18
COIXGNP21100	GN 2/1 65x53 h 10 cm	6	€ 65,70
COIXGNP21150	GN 2/1 65x53 h 15 cm	6	€ 89,33
COIXGNP21200	GN 2/1 65x53 h 20 cm	6	€ 119,55

BACINELLA INOX GN 1/1
STAINLESS STEEL PAN GN 1/1



CODE	DESCRIZIONE - DESCRIPTION	UDV	IVA esc.
COIXGNP11020	GN 1/1 53x32,5 h 2 cm	6	€ 19,90
COIXGNP11040	GN 1/1 53x32,5 h 4 cm	6	€ 22,53
COIXGNP11055	GN 1/1 53x32,5 h 5,5 cm	6	€ 31,63
COIXGNP11065	GN 1/1 53x32,5 h 6,5 cm	6	€ 24,98
COIXGNP11100	GN 1/1 53x32,5 h 10 cm	6	€ 31,28
COIXGNP11150	GN 1/1 53x32,5 h 15 cm	6	€ 42,20
COIXGNP11200	GN 1/1 53x32,5 h 20 cm	6	€ 51,10

BACINELLA INOX GN 2/3

STAINLESS STEEL PAN GN 2/3



CODE	DESCRIZIONE - DESCRIPTION	UDV	IVA esc.
COIXGNP23020	GN 2/3 35,4x32,5 h 2 cm	6	€ 18,18
COIXGNP23065	GN 2/3 35,4x32,5 h 6,5 cm	6	€ 24,60
COIXGNP23100	GN 2/3 35,4x32,5 h 10 cm	6	€ 33,05
COIXGNP23150	GN 2/3 35,4x32,5 h 15 cm	6	€ 39,18
COIXGNP23200	GN 2/3 35,4x32,5 h 20 cm	6	€ 47,15

BACINELLA INOX GN 2/4

STAINLESS STEEL PAN GN 2/4



CODE	DESCRIZIONE - DESCRIPTION	UDV	IVA esc.
COIXGNP24020	GN 2/4 16,2x53 h 2 cm	6	€ 19,83
COIXGNP24040	GN 2/4 16,2x53 h 4 cm	6	€ 22,37
COIXGNP24065	GN 2/4 16,2x53 h 6,5 cm	6	€ 24,53
COIXGNP24100	GN 2/4 16,2x53 h 10 cm	6	€ 32,65
COIXGNP24150	GN 2/4 16,2x53 h 15 cm	6	€ 40,48

BACINELLA INOX GN 1/2

STAINLESS STEEL PAN GN 1/2



CODE	DESCRIZIONE - DESCRIPTION	UDV	IVA esc.
COIXGNP12020	GN 1/2 26,5x32,5 h 2 cm	6	€ 11,20
COIXGNP12040	GN 1/2 26,5x32,5 h 4 cm	6	€ 14,90
COIXGNP12065	GN 1/2 26,5x32,5 h 6,5 cm	6	€ 17,03
COIXGNP12100	GN 1/2 26,5x32,5 h 10 cm	6	€ 19,10
COIXGNP12150	GN 1/2 26,5x32,5 h 15 cm	6	€ 26,75
COIXGNP12200	GN 1/2 26,5x32,5 h 20 cm	6	€ 29,58

BACINELLA INOX GN 1/3

STAINLESS STEEL PAN GN 1/3



CODE	DESCRIZIONE - DESCRIPTION	UDV	IVA esc.
COIXGNP13020	GN 1/3 32,5x17,6 h 2 cm	6	€ 10,05
COIXGNP13040	GN 1/3 32,5x17,6 h 4 cm	6	€ 11,28
COIXGNP13065	GN 1/3 32,5x17,6 h 6,5 cm	6	€ 11,60
COIXGNP13100	GN 1/3 32,5x17,6 h 10 cm	6	€ 14,15
COIXGNP13150	GN 1/3 32,5x17,6 h 15 cm	6	€ 18,93
COIXGNP13200	GN 1/3 32,5x17,6 h 20 cm	6	€ 24,30

BACINELLA INOX GN 1/4

STAINLESS STEEL PAN GN 1/4



CODE	DESCRIZIONE - DESCRIPTION	UDV	IVA esc.
COIXGNP14065	GN 1/4 26,5x16,2 h 6,5 cm	6	€ 10,95
COIXGNP14100	GN 1/4 26,5x16,2 h 10 cm	6	€ 12,83
COIXGNP14150	GN 1/4 26,5x16,2 h 15 cm	6	€ 16,18
COIXGNP14200	GN 1/4 26,5x16,2 h 20 cm	6	€ 21,30

BACINELLA INOX GN 1/6

STAINLESS STEEL PAN GN 1/6



CODE	DESCRIZIONE - DESCRIPTION	UDV	IVA esc.
COIXGNP16020	GN 1/6 17,6x16,2 h 2 cm	6	€ 6,58
COIXGNP16065	GN 1/6 17,6x16,2 h 6,5 cm	6	€ 8,88
COIXGNP16100	GN 1/6 17,6x16,2 h 10 cm	6	€ 10,05
COIXGNP16150	GN 1/6 17,6x16,2 h 15 cm	6	€ 13,00
COIXGNP16200	GN 1/6 17,6x16,2 h 20 cm	6	€ 23,43

BACINELLA INOX GN 1/9

STAINLESS STEEL PAN GN 1/9



CODE	DESCRIZIONE - DESCRIPTION	UDV	IVA esc.
COIXGNP19065	GN 1/9 10,8x17,6 h 6,5 cm	6	€ 8,20
COIXGNP19100	GN 1/9 10,8x17,6 h 10 cm	6	€ 10,25

BACINELLA GN 2/1 FORATA

STAINLESS STEEL GN 2/1 PERFORATED PAN



CODE	DESCRIZIONE - DESCRIPTION	UDV	IVA esc.
COIXGPP21040	GN 2/1 forata 65x53 h 4 cm	6	€ 60,53
COIXGPP21065	GN 2/1 forata 65x53 h 6,5 cm	6	€ 69,38
COIXGPP21100	GN 2/1 forata 65x53 h 10 cm	6	€ 77,98
COIXGPP21150	GN 2/1 forata 65x53 h 15 cm	6	€ 94,82

BACINELLA GN 1/1 FORATA

STAINLESS STEEL GN 1/1 PERFORATED PAN

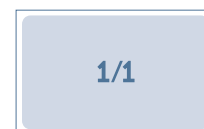

CODE	DESCRIZIONE - DESCRIPTION	UDV	IVA esc.
COIXGPP11020	GN 1/1 forata 53x32,5 h 2 cm	6	€ 26,73
COIXGPP11040	GN 1/1 forata 53x32,5 h 4 cm	6	€ 29,83
COIXGPP11065	GN 1/1 forata 53x32,5 h 6,5 cm	6	€ 32,80
COIXGPP11100	GN 1/1 forata 53x32,5 h 10 cm	6	€ 44,45
COIXGPP11150	GN 1/1 forata 53x32,5 h 15 cm	6	€ 60,65
COIXGPP11200	GN 1/1 forata 53x32,5 h 20 cm	6	€ 104,24

BACINELLA GN 1/2 FORATA

STAINLESS STEEL GN 1/2 PERFORATED PAN



CODE	DESCRIZIONE - DESCRIPTION	UDV	IVA esc.
COIXGPP12020	GN 1/2 forata 32,5x26,5 h 2 cm	6	€ 15,10
COIXGPP12040	GN 1/2 forata 32,5x26,5 h 4 cm	6	€ 19,38
COIXGPP12065	GN 1/2 forata 32,5x26,5 h 6,5 cm	6	€ 24,70
COIXGPP12100	GN 1/2 forata 32,5x26,5 h 10 cm	6	€ 29,58
COIXGPP12150	GN 1/2 forata 32,5x26,5 h 15 cm	6	€ 37,48

BACINELLA GN 1/3 FORATA

STAINLESS STEEL GN 1/3 PERFORATED PAN



CODE	DESCRIZIONE - DESCRIPTION	UDV	IVA esc.
COIXGPP13040	GN 1/3 forata 32,5x17,6 h 4 cm	6	€ 13,43
COIXGPP13065	GN 1/3 forata 32,5x17,6 h 6,5 cm	6	€ 18,91
COIXGPP13100	GN 1/3 forata 32,5x17,6 h 10 cm	6	€ 30,91

FONDO FORATO

PERFORATED BOTTOM



CODE	DESCRIZIONE - DESCRIPTION	UDV	IVA esc.
COIXGND11000	GN 1/1 53x32,5 cm	6	€ 23,13
COIXGND12000	GN 1/2 26,5x32,5 cm	6	€ 11,78
COIXGND13000	GN 1/3 32,5x17,6 cm	6	€ 8,08
COIXGND23000	GN 2/3 35,4x32,5 cm	6	€ 22,96

COPERCHIO STANDARD

STANDARD LID



CODE	DESCRIZIONE - DESCRIPTION	UDV	IVA esc.
COIXGNL11000	GN 1/1 53x32,5 cm	6	€ 19,35
COIXGNL23000	GN 2/3 35,4x32,5 cm	6	€ 15,35
COIXGNL12000	GN 1/2 26,5x32,5 cm	6	€ 9,43
COIXGNL13000	GN 1/3 32,5x17,6 cm	6	€ 7,73
COIXGNL14000	GN 1/4 26,5x16,2 cm	6	€ 6,60
COIXGNL16000	GN 1/6 17,6x16,2 cm	6	€ 5,03
COIXGNL19000	GN 1/9 10,8x17,6 cm	6	€ 4,98

COPERCHIO CON GUARNIZIONE IN SILICONE E VALVOLA

LID WITH SILICONE GASKET AND VALVE



CODE	DESCRIZIONE - DESCRIPTION	UDV	IVA esc.
COIXGXL11000	GN 1/1 53x32,5 cm	6	€ 88,86
COIXGXL23000	GN 2/3 35,4x32,5 cm	6	€ 72,55
COIXGXL12000	GN 1/2 32,5x26,5 cm	6	€ 69,89
COIXGXL13000	GN 1/3 32,5x17,6 cm	6	€ 59,51
COIXGXL14000	GN 1/4 26,5x16,2 cm	6	€ 45,64
COIXGXL16000	GN 1/6 17,6x16,2 cm	6	€ 40,79

COPERCHIO CON FORO

LID WITH HOLE



CODE	DESCRIZIONE - DESCRIPTION	UDV	IVA esc.
COIXGNLN11000	GN 1/1 53x32,5 cm	6	€ 23,25
COIXGNLN12000	GN 1/2 32,5x26,5 cm	6	€ 12,65
COIXGNLN13000	GN 1/3 32,5x17,6 cm	6	€ 9,33
COIXGNLN16000	GN 1/6 17,6x16,2 cm	6	€ 6,58
COIXGNLN19000	GN 1/9 10,8x17,6 cm	6	€ 5,83

GUIDA SUPPORTO

LID WITH HOLE



CODE	DESCRIZIONE - DESCRIPTION	UDV	IVA esc.
COIXGNS11000	GN 1/1 - 53 cm	6	€ 8,14
COIXGNS12000	GN 1/2 - 32,5 cm	6	€ 5,35



**TEGLIA RETTANGOLARE
IN LEGA ALLUMINIO 3003 CON ORLO**

RECTANGULAR BAKING SHEET,
ALU ALLOY 3003, WITH RIM

Code	cm	H cm	IVA esc.
COAL49/330	30x23	3	18,49 €
COAL49/335	35x28	3	19,09 €
COAL49/340	40x30	3	19,68 €
COAL49/345	45x35	3	22,23 €
COAL49/350	50x35	3	24,80 €
COAL49/355	55x38	3	30,26 €
COAL49/360	60x40	3	35,73 €
COAL49/365	65x45	3	45,81 €



**TEGLIA RETTANGOLARE IN LEGA ALLUMINIO
3003 CON RIVESTIMENTO ANTIADERENTE**

RECTANGULAR BAKING SHEET,
ALU ALLOY 3003, NON-STICK COATING

Code	cm	H cm	IVA esc.
COSA49/3S35	35x28	3	45,37 €
COSA49/3S40	40x30	3	55,57 €
COSA49/3S45	45x35	3	65,35 €
COSA49/3S50	50x35	3	69,91 €
COSA49/3S60	60x40	3	85,67 €



**TEGLIA RETTANGOLARE IN LEGA ALLUMINIO
3003 SPESSORE MM 1.5 CON BORDI DRITTI**

RECTANGULAR PAN 3003 ALLOY,
1,5 MM. THICK, STRAIGHT EDGES

Code	cm	H cm	IVA esc.
COAL49/2D60	60x40	2	35,73 €

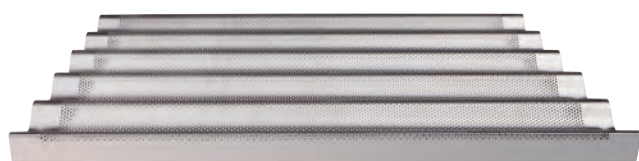

**TEGLIA MICROFORATA PER BAGUETTES
IN ALLUMINIO**

BAKING SHEET WITH MOULDS FOR FRENCH
LOAVES, MICROPERFORATED, ALUMINUM

Code	cm	H cm	IVA esc.
COAL49B60	60x40	3,5	85,29 €

NEW

TEGLIA PER PINSA IN LAMIERA BLU

BLUE SHEET METAL PINSA PAN



Code	cm	H cm	IVA esc.
COFE149BD50X20X2	50 x 20	2	21,58 €
COFE149BD60X20X2	60 x 20	2	23,59 €

TEGLIA RETTANGOLARE IN LEGA ALLUMINIO 3003 FORATA (Ø FORO 6MM)

RECTANGULAR BAKING SHEET,
 PERFORATED ALU ALLOY 3003



Code	cm	H cm	IVA esc.
COAL49/3F35	35x28	3	24,59 €
COAL49/3F40	40x30	3	26,90 €
COAL49/3F45	45x35	3	32,37 €
COAL49/3F50	50x35	3	34,25 €
COAL49/3F60	60x40	3	49,34 €

TEGLIA RETTANGOLARE IN LEGA ALLUMINIO 3003 SPESSORE MM 1.2 CON BORDI DRITTI

RECTANGULAR PAN 3003 ALLOY,
 1.2 MM. THICK, STRAIGHT EDGES



Code	cm	H cm	IVA esc.
COAL49/2DL60	60x40	2	33,62 €

TEGLIA RETTANGOLARE IN LAMIERA ALLUMINATA

RECTANGULAR BAKING SHEET, ALUSTEEL



Code	cm	H cm	IVA esc.
COAL149AL40	40x30	3	18,49 €
COAL149AL50	50x35	3	19,33 €
COAL149AL60	60x40	3	25,64 €

TEGLIA RETTANGOLARE IN LEGA ALLUMINIO MICROFORATA (Ø FORO 2 MM) CON RIVESTIMENTO ANTIADERENTE

RECTANGULAR BAKING SHEET, MICROPERFORATED - ALU ALLOY 3003 (NO-STICK COATING)

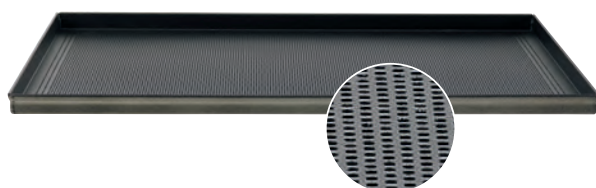

Code	cm	H cm	IVA esc.
COSA49/2MFS60	60x40	2	95,17 €

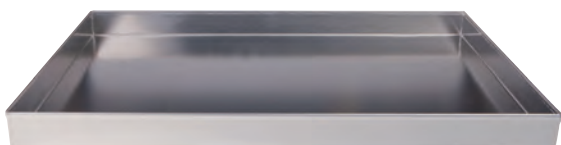

**TEGLIA RETTANGOLARE IN LEGA
 ALLUMINIO 3003 CON BORDI DRITTI**

RECTANGULAR PAN 3003 ALLOY, STRAIGHT EDGES

Code	cm	H cm	IVA esc.
COAL49/4D60	60x40	4	44.19 €



**TEGLIA RETTANGOLAR IN LAMIERA
 ALLUMINATA CON BORDI DRITTI**

RECTANGULAR PAN, ALUSTEEL, STRAIGHT EDGES

Code	cm	H cm	IVA esc.
COAL149AL260	60x40	2	22.71 €
COAL149AL280	80x60	2	37.83 €



**TEGLIA RETTANGOLARE IN LEGA
 ALLUMINIO 3003 MICROFORATA (Ø FORO 2
 MM)**

RECTANGULAR BAKING SHEET,
 MICROPERFORATED - ALU ALLOY 3003

Code	cm	H cm	IVA esc.
COAL49/2MF60	60x40	2	53.45 €
COAL49/2MF80	80x60	2	80.25 €

**TEGLIA RETTANGOLARE
 IN LAMIERA BLU PER DOLCI E PIZZE**

BLUE STEEL RECTANGULAR BAKING SHEETS
 FOR CAKES AND PIZZAS (LOOSE)



Code	cm	H cm	IVA esc.
COFE149B30	30x23	3	13.93 €
COFE149B35	35x28	3	16.01 €
COFE149B40	40x30	3	17.54 €
COFE149B45	45x35	3	20.27 €
COFE149B50	50x35	3	21.35 €
COFE149B55	55x38	3	24.60 €
COFE149B60	60x40	3	25.78 €
COFE149B65	65x45	3	30.33 €



**TEGLIA RETTANGOLARE DIAMANTATA*
IN LEGA ALLUMINIO 3003 CON BORDI DRITTI**

RECTANGULAR PAN 3003 ALLOY, STRAIGHT EDGES

Code	cm	H cm	IVA esc.
COAL49/2XD55	55x38	2	32,03 €
COAL49/2XD60	60x40	2	43,71 €
COAL49/2XD65	65x45	2	56,32 €

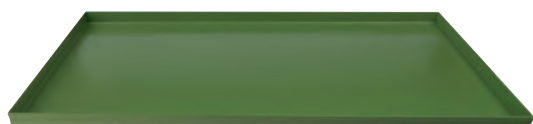

**TEGLIA RETTANGOLARE IN LAMIERA
ALLUMINATA ANTIADERENTE
(RIVESTIMENTO PER PANIFICATORI) CON
BORDI DRITTI**

RECTANGULAR PAN, NON-STICK ALUSTEEL
(COATED FOR BAKERIES), STRAIGHT EDGES

Code	cm	H cm	IVA esc.
COSA149AL2V60	60x40	2	79,84 €
COSA149AL2V80	80x60	2	126,59 €



**TEGLIA ALLUMINATA PER
FOCACCINE (8 STAMPI Ø 14)**

BAKING SHEET FOR MUFFIN PAN
(8 MOULDES Ø 14), ALUSTEEL

Code	cm	H cm	IVA esc.
COAL49/860	60x40	2,5	75,89 €

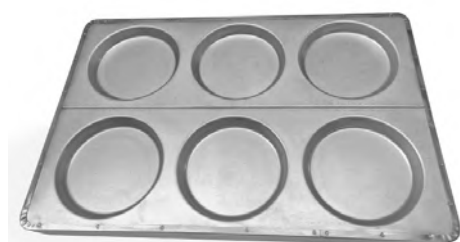

NEW

**TEGLIA ALLUMINATA PER
FOCACCINE (6 STAMPI Ø 16)**

BAKING SHEET FOR MUFFIN PAN
(6 MOULDES Ø 16), ALUSTEEL

Code	cm	H cm	IVA esc.
COAL49/660	60x40	2,5	67,23 €



**TEGLIA RETTANGOLARE DIAMANTATA*
 IN LAMIERA BLU PER DOLCI E PIZZE
 CON BORDI DRITTI**

BLUE STEEL RECTANGULAR BAKING SHEETS
 FOR CAKES AND PIZZAS (LOOSE)

Code	cm	H cm	IVA esc.
COFE149BXD60	60x40	2	26,64 €

* alta resistenza alla deformazione durante la cottura

* high resistance to deformation during cooking

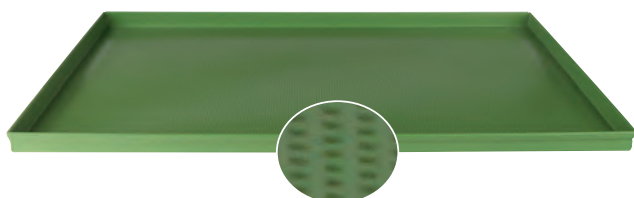

**TEGLIA RETTANGOLARE IN LEGA
 ALLUMINIO MICROFORATA (Ø FORO 2
 MM) ANTIADERENTE (RIVESTIMENTO PER
 PANIFICATORI) CON BORDI DRITTI**

RECTANGULAR PAN, MICROPERFORATED,
 NON-STICK (COATED FOR BAKERIES), STRAIGHT
 EDGES

Code	cm	H cm	IVA esc.
COSA49/2MFV60	60x40	2	94,96 €
COSA49/2MFV80	80x60	2	165,11 €

**ANELLO PAN DI SPAGNA ANTIADERENTE
 5 MM MISURA Ø ESTERNO**

SPONGE CAKE RING - TEFLON® 5 MM Ø OUTSIDE



Code	Ø cm	H cm	IVA esc.
ALSA43AS15X4	15	4	55,26 €
ALSA43AS15X5	15	5	59,74 €
ALSA43AS20X4	20	4	64,20 €
ALSA43AS20X5	20	5	69,50 €
ALSA43AS25X4	25	4	81,46 €
ALSA43AS25X5	25	5	85,77 €

VASSOIO OX

TRAY



Code	cm	H cm	IVA esc.
COAL182OX22,5	22,5x22,5	1,5	20,05 €
COAL182OX23	23x14,5	1,5	15,56 €
COAL182OX30	30x18	1,5	21,10 €
COAL182OX30,5	30,5x22,5	1,5	23,12 €
COAL182OX37,5	37,5x24,5	1,5	30,73 €
COAL182OX48	48x31	1,5	45,05 €
COAL182OX60	60x40	1,5	78,83 €

VASSOIO OX ORO

GOLD TRAY



Code	cm	H cm	IVA esc.
COAL182OR22,5	22,5x22,5	1,5	23,06 €
COAL182OR23	23x14,5	1,5	18,39 €
COAL182OR30	30x18	1,5	24,52 €
COAL182OR30,5	30,5x22,5	1,5	27,50 €
COAL182OR37,5	37,5x24,5	1,5	36,36 €
COAL182OR48	48x31	1,5	54,12 €
COAL182OR60	60x40	1,5	93,24 €



RASCHIA RETTANGOLARE INOX

RECTANGULAR DOUGH SCRAPER, S/S

Code	cm	IVA esc.
COIX41RX13	13x13	10,18 €
COIX41RX16	16x13	12,21 €
COIX41RX18	18x13	13,44 €

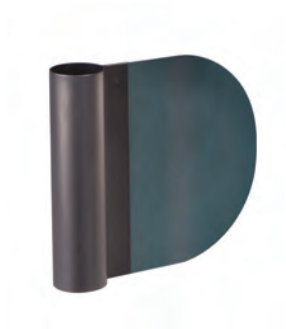

RASCHIA TONDA IN LAMIERA BLU

ROUND DOUGH SCRAPER, BLUE STEEL

Code	cm	IVA esc.
COFE41TB12	12	7,48 €



**TORTIERA CONICA IN ALLUMINIO
 CON ORLO (H CM 3)**

ALU CONICAL CAKE-PAN WITH RIM

Code	Ø cm	H cm	IVA esc.
FAMA43/314	14	3	8,03 €
FAMA43/316	16	3	8,52 €
FAMA43/318	18	3	8,81 €
FAMA43/320	20	3	9,05 €
FAMA43/322	22	3	9,74 €
FAMA43/324	24	3	10,03 €
FAMA43/326	26	3	10,46 €
FAMA43/328	28	3	11,13 €
FAMA43/330	30	3	12,91 €
FAMA43/332	32	3	15,59 €
FAMA43/334	34	3	17,02 €
FAMA43/336	36	3	17,50 €
FAMA43/338	38	3	18,13 €
FAMA43/340	40	3	18,30 €
FAMA43/345	45	3	24,19 €
FAMA43/350	50	3	31,15 €

**TORTIERA CONICA IN ALLUMINIO
 CON ORLO (H CM 8)**

ALU CONICAL CAKE-PAN WITH RIM



Code	Ø cm	H cm	IVA esc.
FAMA43/816	16	8	10,75 €
FAMA43/818	18	8	11,21 €
FAMA43/820	20	8	11,38 €
FAMA43/822	22	8	12,13 €
FAMA43/824	24	8	12,77 €
FAMA43/826	26	8	13,55 €
FAMA43/828	28	8	14,63 €
FAMA43/830	30	8	16,38 €
FAMA43/832	32	8	18,52 €
FAMA43/834	34	8	19,13 €
FAMA43/836	36	8	20,76 €
FAMA43/838	38	8	23,73 €
FAMA43/840	40	8	25,25 €

**ANELLO PAN DI SPAGNA ALLUMINIO
 5 MM MISURA Ø ESTERNO**

SPONGE CAKE RING

ALU 5 MM Ø OUTSIDE



Code	Ø cm	H cm	IVA esc.
ALMA43A15X4	15	4	31,32 €
ALMA43A15X5	15	5	35,62 €
ALMA43A20X4	20	4	40,11 €
ALMA43A20X5	20	5	44,58 €
ALMA43A25X4	25	4	53,36 €
ALMA43A25X5	25	5	57,84 €

**TORTIERA CONICA IN ALLUMINIO
 CON ORLO (H CM 6)**

ALU CONICAL CAKE-PAN WITH RIM



Code	Ø cm	H cm	IVA esc.
FAMA43/616	16	6	8,81 €
FAMA43/618	18	6	9,38 €
FAMA43/620	20	6	9,82 €
FAMA43/622	22	6	10,39 €
FAMA43/624	24	6	11,15 €
FAMA43/626	26	6	11,92 €
FAMA43/628	28	6	12,56 €
FAMA43/630	30	6	13,84 €
FAMA43/632	32	6	16,23 €
FAMA43/634	34	6	17,78 €
FAMA43/636	36	6	18,30 €
FAMA43/638	38	6	18,75 €
FAMA43/640	40	6	19,61 €
FAMA43/650	50	6	33,15 €

TORTIERA CONICA IN LEGA 3003 FORATA

PERFORATED ROUND CAKE-PAN - ALLOY 3003



Code	Ø cm	H cm	IVA esc.
FAMA43/3F26	26	3	16,77 €
FAMA43/3F28	28	3	18,82 €
FAMA43/3F30	30	3	21,86 €
FAMA43/3F32	32	3	24,19 €
FAMA43/3F36	36	3	26,35 €
FAMA43/3F40	40	3	27,17 €
FAMA43/3F50	50	3	41,66 €

TORTIERA ALTA IN LAMIERA BLU PER PIZZE

BLUE STEEL ROUND PIZZASHEET (PACK 10 PCS)



Code	Ø cm	H cm	IVA esc.
COFE43BB18	18	4	6,82 €
COFE43BB20	20	4	7,34 €
COFE43BB22	22	4	7,60 €
COFE43BB24	24	4	7,99 €
COFE43BB26	26	4	9,12 €
COFE43BB28	28	4	9,85 €
COFE43BB30	30	4	10,34 €
COFE43BB32	32	4	12,20 €
COFE43BB36	36	4	14,50 €
COFE43BB40	40	4	17,83 €
COFE43BB45	45	3,5	27,94 €
COFE43BB50	50	3,5	30,33 €
COFE43BB60	60	3,5	41,04 €



TORTIERA IN LAMIERA BLU PER PIZZE

BLUE STEEL ROUND PIZZASHEET (PACK 10 PCS)

Code	Ø cm	H cm	IVA esc.
COFE43B14	14	2,2	4,95 €
COFE43B16	16	2,3	5,30 €
COFE43B18	18	2,5	5,56 €
COFE43B20	20	2,5	5,65 €
COFE43B22	22	2,5	6,34 €
COFE43B24	24	2,5	6,56 €
COFE43B26	26	2,5	7,04 €
COFE43B28	28	2,5	8,08 €
COFE43B30	30	2,5	8,90 €
COFE43B32	32	2,5	9,42 €
COFE43B36	36	2,5	12,76 €
COFE43B40	40	2,5	16,36 €



BLUE STEEL CAKE-PAN, NON-STICK COATING

BLUE STEEL CAKE-PAN, NON-STICK COATING

Code	Ø cm	H cm	IVA esc.
COFE43BS20	20	2,5	17,25 €
COFE43BS24	24	2,5	18,53 €
COFE43BS26	26	2,5	20,51 €
COFE43BS28	28	2,5	23,45 €
COFE43BS32	32	2,5	27,07 €



TORTIERA PESANTE PER PIZZA AL TRANCIO CON ORLO (H CM 4,5)

ROUND CAKE-PAN, ALLOY 3003, NON-STICK COATING

Code	Ø cm	H cm	IVA esc.
COAL143P50	50 (est)	4,5	46,67 €



TORTIERA IN LEGA 3003 CON RIVESTIMENTO ANTIADERENTE (H CM 3)

ROUND CAKE-PAN, ALLOY 3003, NON-STICK COATING

Code	Ø cm	H cm	IVA esc.
ALSA43/3S26	26	3	31,51 €
ALSA43/3S28	28	3	39,92 €
ALSA43/3S30	30	3	42,02 €
ALSA43/3S32	32	3	54,64 €



STAMPO AMERICANO CON TUBO IN ALLUMINIO

CAKE MOULD "GUGELHOPF" WITH TUBE

Code	Ø cm	H cm	IVA esc.
COAL3516	16	9	12,24 €
COAL3518	18	10	14,67 €
COAL3520	20	11	18,23 €
COAL3522	22	11	18,31 €



STAMPO AMERICANO SENZA TUBO IN ALLUMINIO

CAKE MOULD "GUGELHOPF" WITHOUT TUBE

Code	Ø cm	H cm	IVA esc.
COAL3018	18	10	11,07 €



STAMPO MARGHERITA IN ALLUMINIO

SPONGE CAKE MOULD

Code	Ø cm	H cm	IVA esc.
COAL3320	20	6,5	10,81 €



STAMPO CONICO PER PANETTONE IN ALLUMINIO

CONICAL MOULD FOR PANETTONE

Code	Ø cm	H cm	IVA esc.
COAL3118	18	11	13,32 €
COAL3120	20	12	16,15 €
COAL3122	22	13	19,91 €
COAL3124	24	19	24,08 €



FORMA PER CREME-CARAMEL ALTO IN ALLUMINIO

CRÈME CARAMEL MOULD, ALU, DEEP

Code	Ø cm	H cm	IVA esc.
ALMA2195	5	6	4,68 €
ALMA2196	6	7	5,02 €
ALMA2196,5	6,5	7	5,24 €
ALMA2197	7	8	5,42 €
ALMA2198	8	9	5,56 €



**FORMA PER CREME-CARAMEL BASSO
 IN ALLUMINIO**

CRÈME CARAMEL MOULD, ALU, LOW

Code	Ø cm	H cm	IVA esc.
ALMB2196,5	6,5	4,5	4,68 €
ALMB2197	7	5	5,24 €
ALMB2198	8	5,5	5,42 €



CIAMBELLA CON TUBO IN ALLUMINIO

SAVARIN MOULD WITH TUBE

Code	Ø cm	H cm	IVA esc.
COAL3720	20	6	12,32 €
COAL3722	22	6,5	13,93 €
COAL3724	24	7,5	15,71 €
COAL3726	26	8,5	17,14 €
COAL3730	30	8,5	25,82 €

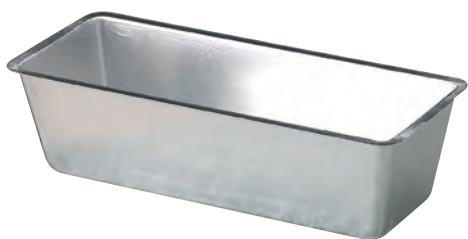

FORMA PLUMCAKE IN ALLUMINIO

PLUMCAKE

Code	cm	H cm	IVA esc.
COAL3818	18	6	8,74 €
COAL3822	22	6,5	9,55 €
COAL3826	26	7,5	10,77 €
COAL3830	30	7,5	13,46 €



**FORMA PAN CARRÈ
 CON COPERCHIO IN LAMIERA BLU**

BLUE STEEL BREAD WITH LID

Code	cm	H cm	IVA esc.
COFE38BC20	20 x 10	10	35,14 €
COFE38BC30	30 x 10	10	36,76 €
COFE38BC40	40 x 10	10	39,21 €



FORMA PER CREME-CARAMEL INOX 18/10

CRÈME CARAMEL MOULD 18/10, S/S

Code	Ø cm	H cm	IVA esc.
COIX32196	6	6	5,27 €
COIX32197	7	7	6,60 €



TORTIERA CONICA CON ANELLO

CONICAL CAKE-PAN WITH RING

Code	Ø cm	H cm	IVA esc.
FAMA4316	16	4,5	8,22 €
FAMA4318	18	4,5	8,75 €
FAMA4320	20	4,5	11,03 €
FAMA4322	22	4,5	11,39 €
FAMA4324	24	5,5	13,13 €
FAMA4326	26	5,5	13,82 €
FAMA4328	28	6,5	15,63 €
FAMA4330	30	7	17,74 €
FAMA4332	32	7	19,43 €
FAMA4334	34	7,5	21,43 €
FAMA4336	36	7,5	23,13 €
FAMA4338	38	8	27,99 €
FAMA4340	40	8	31,49 €



TORTIERA CILINDRICA CON ANELLO

CYLINDRIC CAKE MOULD WITH RING

Code	Ø cm	H cm	IVA esc.
FAMA6616	16	3	9,11 €
FAMA6618	18	3,5	11,03 €
FAMA6620	20	4	11,89 €
FAMA6622	22	5	13,67 €
FAMA6624	24	6	13,84 €
FAMA6626	26	6,5	16,44 €
FAMA6628	28	6,5	17,44 €
FAMA6630	30	7	19,43 €
FAMA6632	32	7	20,47 €
FAMA6634	34	7	26,15 €
FAMA6636	36	7,5	29,44 €
FAMA6638	38	7,5	30,12 €
FAMA6640	40	8	36,39 €



TORTIERA IN ALLUMINIO

CAKE MOULD

Code	Ø cm	H cm	IVA esc.
COAL43LE16	16	4	5,66 €
COAL43LE18	18	4	5,87 €
COAL43LE20	20	4	6,66 €
COAL43LE22	22	4,5	7,13 €
COAL43LE24	24	4,5	7,76 €
COAL43LE26	26	4,5	8,18 €
COAL43LE28	28	5	9,39 €
COAL43LE30	30	5	10,13 €



STAMPO BUDINO CON TUBO IN ALLUMINIO

PUDDING MOULD WITH TUBE

Code	Ø cm	H cm	IVA esc.
COAL35LE07	7	5	5,24 €
COAL35LE10	10	5	5,87 €
COAL35LE12	12	6	7,01 €
COAL35LE14	14	7	7,55 €
COAL35LE16	16	8	10,36 €
COAL35LE18	18	8,5	10,82 €
COAL35LE20	20	10	12,98 €
COAL35LE22	22	10	13,51 €



STAMPO BUDINO SENZA TUBO IN ALLUMINIO

PUDDING MOULD WITHOUT TUBE

Code	Ø cm	H cm	IVA esc.
COAL30LE07	7	5	3,38 €
COAL30LE10	10	5	3,92 €
COAL30LE12	12	6	4,90 €
COAL30LE14	14	7	5,47 €
COAL30LE16	16	8	7,38 €
COAL30LE18	18	8,5	7,80 €
COAL30LE20	20	10	9,03 €
COAL30LE22	22	10	9,71 €

CIAMBELLA CON TUBO IN ALLUMINIO

SAVARIN MOULD WITH TUBE



Code	Ø cm	H cm	IVA esc.
COAL43TU16	16	4	7,50 €
COAL43TU18	18	4	7,76 €
COAL43TU20	20	4	8,71 €
COAL43TU22	22	4,5	9,03 €
COAL43TU24	24	4,5	10,08 €
COAL43TU26	26	4,5	10,55 €
COAL43TU28	28	5	12,41 €
COAL43TU30	30	5	12,65 €

CIAMBELLONE LISCIO CON TUBO IN ALLUMINIO

BIG SAVARIN MOULD WITH TUBE



Code	Ø cm	H cm	IVA esc.
COAL37LE22	22	7	12,61 €
COAL37LE24	24	7	14,09 €
COAL37LE26	26	8	15,72 €
COAL37LE28	28	8,5	19,73 €

PLUMCAKE IN ALLUMINIO ANTIADERENTE

PLUMCAKE MOULD



Code	Ø cm	H cm	IVA esc.
COFA43826	26x10	10	9,63 €

Agnelli
SINCE 1907

ESPOSITORE DA TERRA IN METALLO

METAL FLOOR DISPLAY WITH 30 HOOKS

CONFIGURAZIONI:
CONFIGURATIONS:



**MENSOLE
E GANCI**

Shelves and
hooks



**SOLO
MENSOLE**

Only shelves



**SOLO
GANCI**

Only
hooks



BIFACCIALE

Double-sided

120cmx200cmx50cm

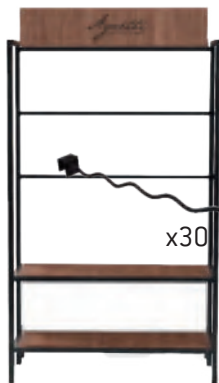

**ESPOSITORE DA TERRA
IN LEGNO E METALLO CON 30 GANCI**

FLOOR DISPLAY IN WOOD AND METAL
WITH 30 HOOKS

Code	IVA esc.
COESPOSITORE	€ 597,80



**KIT MENSOLA AGGIUNTIVA PER ESPOSITORE
ADDITIONAL SHELF KIT FOR DISPLAY**

Code	IVA esc.
COESPOKITME	€ 114,33



**PANNELLO IN LEGNO PER ESPOSITORE DA
TERRA**

WOODEN PANEL FOR FLOOR STANDING METAL
DISPLAY

Code	IVA esc.
INT.PANLEGNO	€ 87,72 €



**PANNELLO FOREX BIFACCIALE
PER ESPOSITORE DA TERRA**

FOREX PANEL FOR FLOOR STANDING METAL
DISPLAY

Code	IVA esc.
INT.PANFOREXPPLY	€ 99,52

KIT BIFACCIALE PER ESPOSITORE DA TERRA

- BASE IN MDF AVVITATA E STACCABILE
CON PIEDINO REGOLABILE
- 12 GANCI ONDULATI

DOUBLE-SIDED FLOOR DISPLAY KIT

- SCREWED AND DETACHABLE MDF BASE WITH ADJUSTABLE FOOT
- 12 WAVY HOOKS



Code	IVA esc.
COESPOKITBI	€ 207,40

Agnelli
SINCE 1907

BARBECUE



GUARNIZIONE
IN FIBRA DI VETRO
FIBERGLASS GASKET

CAMINO REGOLABILE
IN GHISA
ADJUSTABLE CAST
IRON FIREPLACE

CONTROLLO COSTANTE
DELLA TEMPERATURA
CONSTANT TEMPERATURE
CONTROL

MENSOLE
E MANIGLIE
IN BAMBOO
BAMBOO
SHELVES
AND HANDLES

CARRELLO
IN ACCIAIO INOX
STAINLESS STEEL
TROLLEY

CERAMICA
CORDIERITE
CORDIERITE
CERAMICS

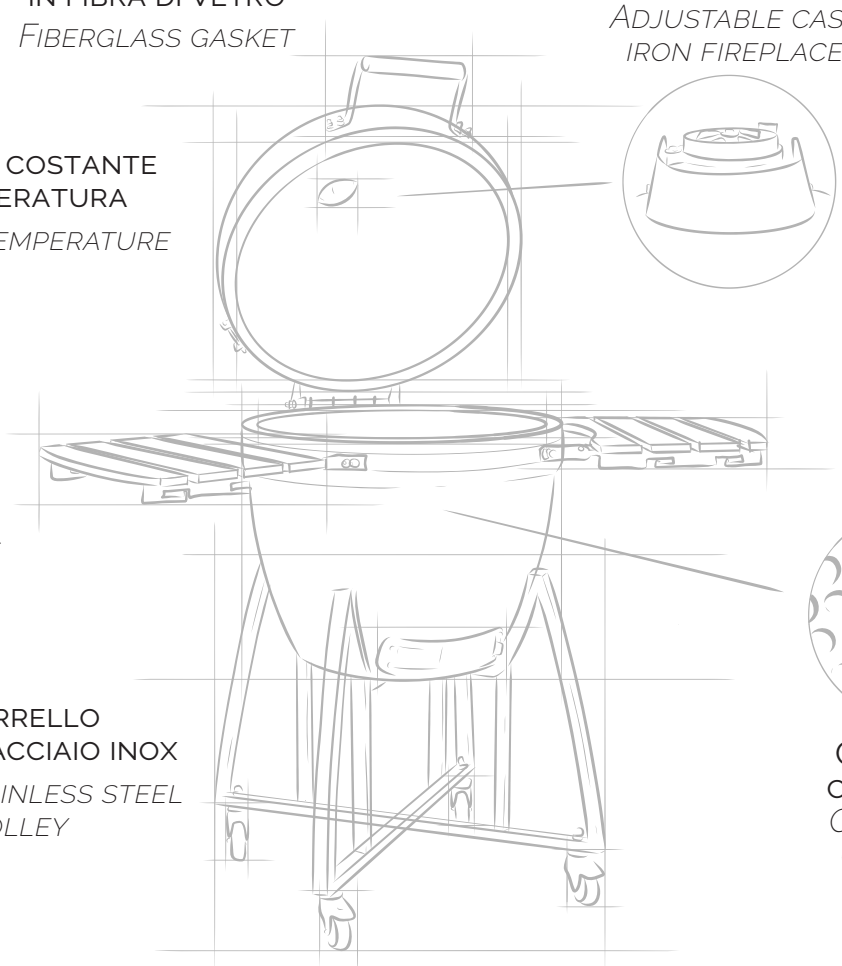

ARROSTIRE
ROAST

GRIGLIARE
GRILLING

AFFUMICARE
SMOKING

CUOCERE A BASSA
TEMPERATURA
COOK AT LOW
TEMPERATURE

SFORNARE PIZZE,
PANE E TORTE
BAKING PIZZAS,
BREAD, AND CAKES

SPECIFICHE TECNICHE
Technical specifications

Diametro BBQ - BBQ diameter	55 cm
Diametro griglia - Grid diameter	47 cm
Area di cottura - Cooking area	1,729 cm ²
T* range	0-800 C°

PESI E DIMENSIONI
Weights and dimensions

Ingombro BBQ - BBQ size	118 x 129,5 x 55 cm
Ingombro Box - Box size	74 x 63 x 86 cm
Peso lordo - Gross weight	105 Kg
Peso netto - Net weight	95 Kg

BBPRO

KAMADO NOT JUST A BBQ



CODICE	PREZZO IVA ESCLUSA
BABBQM	€ 2.029,14

LA CONFEZIONE COMPRENDE:



Griglia in acciaio
Steel grill

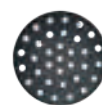

Griglia per carbonella
Charcoal grill



Focolare
Hearth



Anello estensore
Extender ring



Copertura antipioggia
Rain cover

ACCESSORI PER BABBQM



GRIGLIA IN ACCIAIO 304 Ø 47 CM

304 STEEL GRILL Ø 47 CM

Code	Iva esc.
<u>BAGRIDM</u>	<u>€ 111,60</u>



GRIGLIA IN GHISA Ø 46,5 CM

CAST IRON GRILL
Ø 46,5 CM

Code	Iva esc.
<u>BACIGRIDM</u>	<u>€ 145,31</u>



GRIGLIA ELEVATOR ACCIAIO INOX 304

ELEVATOR GRILL
304 STAINLESS STEEL

Code	Iva esc.
<u>BAGRIDELM</u>	<u>€ 76,73</u>



GRIGLIA 2 LIVELLI ACCIAIO INOX 304 (MEZZELUNE ESCLUSE)

2-TIER 304 STAINLESS STEEL GRILL (CRESCENTS NOT INCLUDED)

Code	Iva esc.
<u>BAGRID2LM</u>	<u>€ 259,82</u>



MEZZELUNE PER COTTURA INDIRECTA IN CERAMICA CORDIERITE

CORDIERITE CERAMIC INDIRECT COOKING CRESCENTS

Code	Iva esc.
<u>BAHMM</u>	<u>€ 67,43</u>



PIATTO SPARGIFIAMMA PER COTTURA INDIRECTA IN CERAMICA CORDIERITE

CORDIERITE CERAMIC FLAME SPREADER PLATE FOR INDIRECT COOKING

Code	Iva esc.
<u>BASFM</u>	<u>€ 101,72</u>



PIETRA PIZZA IN CERAMICA CORDIERITE Ø 36 CM

CORDIERITE CERAMIC PIZZA STONE Ø 36 CM

Code	Iva esc.
<u>BAPSM</u>	<u>€ 55,80</u>



CUOCI RIBS IN ACCIAIO 304

RIB COOKER IN 304 STAINLESS STEEL

Code	Iva esc.
<u>BACRLM</u>	<u>€ 49,41</u>



COLTELLO PIZZA 35X10 CM

PIZZA KNIFE 35X10 CM

Code	Iva esc.
<u>BAPK</u>	<u>€ 24,99</u>

ACCESSORIES FOR BABBQM



CESTO PER CARBONELLA IN ACCIAIO

STEEL CHARCOAL BASKET

Code	IVA esc.
BACBLM	€ 165,66



GUARNIZIONE IN FIBRA DI VETRO

FIBERGLASS GASKET

Code	IVA esc.
BAFGM	€ 69,75



GANCIO SOLLEVA GRIGLIA E COPERCHI

LIFTING HOOK
GRILL AND LIDS
25X10X4 CM

Code	IVA esc.
BALH	€ 29,95



ALLOGGIAMENTO CUOCIPOLLO IN ARGILLA

CLAY CHICKEN COOKER HOUSING

Code	IVA esc.
BACP	€ 23,25



GIRAROSTO ELETTRICO

GIRAROSTO ELETTRICO

Code	IVA esc.
BAGAM	€ 494,06

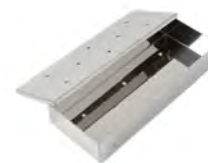

BOX PORTA CHIPS PER AFFUMICATURA

BOX FOR SMOKING CHIPS

Code	IVA esc.
BASB	€ 49,41



PORTA ATTREZZI PER MENSOLA CON 4 GANCI

SHELF TOOL HOLDER WITH 4 HOOKS

Code	IVA esc.
BAPA	€ 26,16



COPERTURA ANTIPIOGGIA

RAIN COVER

Code	IVA esc.
BARCM	€ 74,98



GUARNIZIONE IN FELTRO

FELT GASKET

Code	IVA esc.
BAFLM	€ 10,46



SET RACCOGLICENERE IN ACCIAIO 201

STEEL ASH COLLECTOR SET 201

Code	IVA esc.
BAAEM	€ 78,47

Agnelli
SINCE 1907



BBPRO
COMPATTO

BBPRO COMPACT

CONTROLLO COSTANTE
DELLA TEMPERATURA
*CONSTANT TEMPERATURE
CONTROL*

MANIGLIE
IN BAMBOO
*BAMBOO
HANDLES*

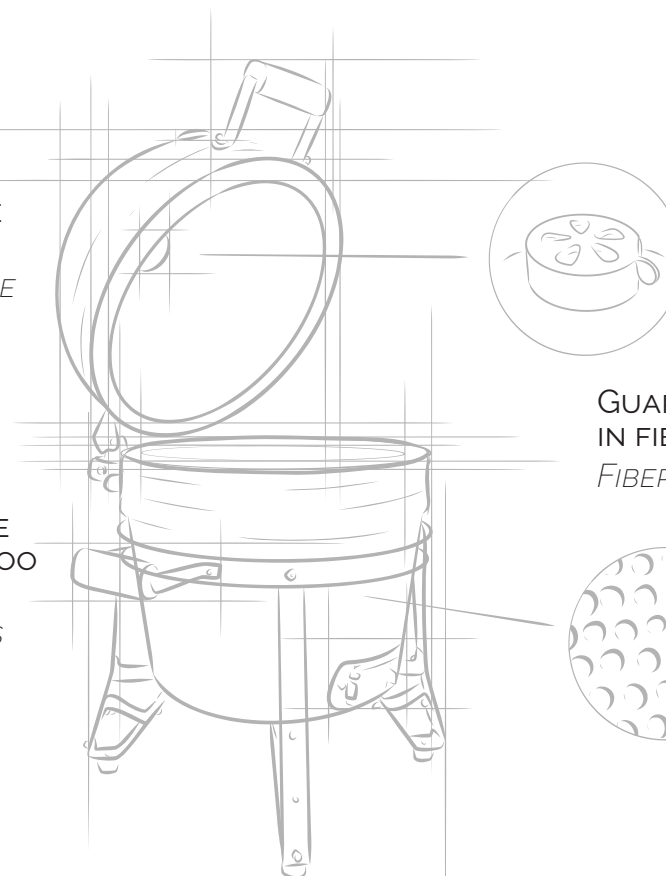

CAMINO REGOLABILE
IN GHISA
*ADJUSTABLE CAST
IRON FIREPLACE*

GUARNIZIONE
IN FIBRA DI VETRO
FIBERGLASS GASKET

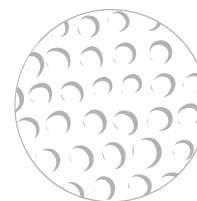

CERAMICA
CORDIERITE
*CORDIERITE
CERAMICS*



DIMENSIONI COMPATTE: IDEALE PER USO
PROFESSIONALE SOTTO CAPPA.

COMPACT SIZE: PERFECT FOR PROFESSIONAL USE UNDER A HOOD.

ARROSTIRE
ROAST

GRIGLIARE
GRILLING

AFFUMICARE
SMOKING

CUOCERE A BASSA
TEMPERATURA

*COOK AT LOW
TEMPERATURE*

SFORNARE PIZZE,
PANE E TORTE

*BAKING PIZZAS,
BREAD, AND CAKES*

SPECIFICHE TECNICHE
Technical specifications

Diametro BBQ - BBQ diameter	40 cm
Diametro griglia - Grid diameter	34 cm
Area di cottura - Cooking area	907 cm ²
T° range	0-800 C°

PESI E DIMENSIONI
Weights and dimensions

Ingombro BBQ - BBQ size	60 x 53 x 40 cm
Ingombro Box - Box size	49 x 45 x 63 cm
Peso lordo - Gross weight	41 Kg
Peso netto - Net weight	38 Kg

BBPRO

KAMADO NOT JUST A BBQ



CODICE	PREZZO IVA ESCLUSA
BABBQC	€ 765,97

LA CONFEZIONE COMPRENDE:



Griglia in acciaio
Steel grill

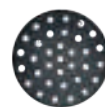

Griglia per carbonella
Charcoal grill



Focolare
Hearth



Anello estensore
Extender ring



Copertura anti-pioggia
Rain cover

ACCESSORI PER BABBQC



GRIGLIA IN ACCIAIO 304 Ø 34 CM

304 STEEL GRILL Ø 34 CM

Code	IVA esc.
BAGRIDC	€ 66,26



GRIGLIA IN GHISA Ø 34,5 CM

CAST IRON GRILL Ø 34,5 CM

Code	IVA esc.
BACIGRIDC	€ 93,00



GRIGLIA ELEVATOR ACCIAIO INOX 304

ELEVATOR GRILL 304 STAINLESS STEEL

Code	IVA esc.
BAGRIDELC	€ 66,84



GRIGLIA 2 LIVELLI ACCIAIO INOX 304 (MEZZELUNE ESCLUSE)

2-TIER 304 STAINLESS STEEL GRILL (CRESCENTS NOT INCLUDED)

Code	IVA esc.
BAGRID2LC	€ 168,56



MEZZELUNE PER COTTURA INDIRETTA IN CERAMICA CORDIERITE

CORDIERITE CERAMIC INDIRECT COOKING CRESCENTS

Code	IVA esc.
BAHMC	€ 49,41



PIETRA Ø 26 CM IN CERAMICA CORDIERITE PER BAGRIDSFC

Ø 26 CM CORDIERITE CERAMIC STONE FOR BAGRIDSFC

Code	IVA esc.
BAP26	€ 50,57



PIETRA PIZZA IN CERAMICA CORDIERITE Ø 29,5 CM

CORDIERITE CERAMIC PIZZA STONE Ø 29,5CM

Code	IVA esc.
BAPSC	€ 53,48



STRUTTURA IN ACCIAIO PER COTTURA INDIRETTA

STEEL STRUCTURE FOR INDIRECT COOKING

Code	IVA esc.
BAGRIDSFC	€ 63,36



COLTELLO PIZZA 35X10 CM

PIZZA KNIFE 35X10 CM

Code	IVA esc.
BAPK	€ 24,99

ACCESSORIES FOR BABBQC



GIRARROSTO ELETTRICO
GIRARROSTO ELETTRICO

Code	IVA esc.
BAGAC	€ 465,00



GUARNIZIONE IN FIBRA DI VETRO
FIBERGLASS GASKET

Code	IVA esc.
BAFGC	€ 41,85



GANCIO SOLLEVA GRIGLIA E COPERCHI
25X10X4 CM
LIFTING HOOK
GRILL AND LIDS
25X10X4 CM

Code	IVA esc.
BALH	€ 29,95



GUARNIZIONE IN FELTRO
FELT GASKET

Code	IVA esc.
BAFC	€ 6,98

BBPRA
KAMADO NOT JUST A

Agnelli
SINCE 1907



BBPRO
HIBACHI

ROUND

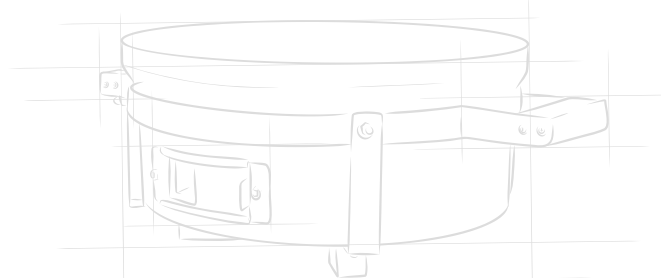
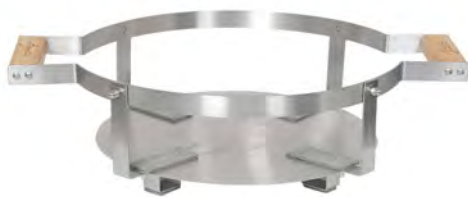
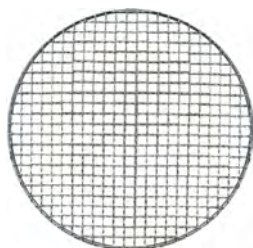

VASCA RACCOGLI-GRASSO: UTILIZZO SICURO ANCHE IN AMBIENTI INTERNI, SENZA FUMO.

GREASE DRIP TRAY: SAFE FOR INDOOR USE, SMOKE-FREE.

SPECIFICHE TECNICHE
Technical specifications

Diametro BBQ - BBQ diameter	30,5 cm
Diametro griglia - Grid diameter	28 cm
T° range	0-430 C°

PESI E DIMENSIONI
Weights and dimensions

Ingombro BBQ - BBQ size	45,5 x 34,5 x 17 cm
Ingombro Box - Box size	53 x 42 x 28 cm
Peso lordo - Gross weight	15 Kg
Peso netto - Net weight	14 Kg

CODICE

BABBQRO

PREZZO IVA ESCLUSA

€ 328,50



Agnelli
SINCE 1907



BBPRO
HIBACHI

BARBECUE

SQUARE

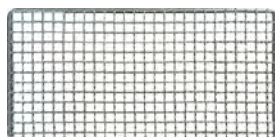
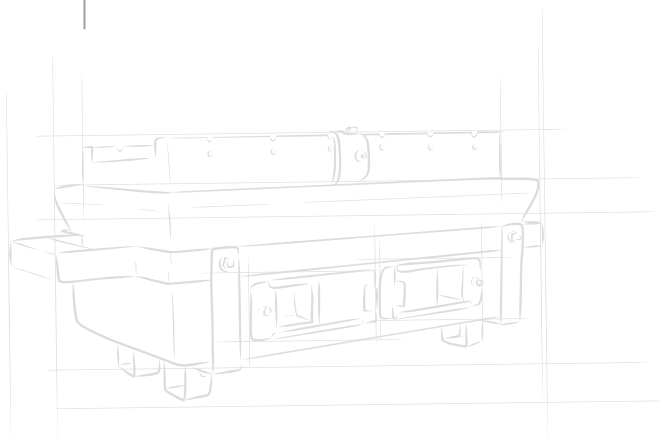

SPECIFICHE TECNICHE

Technical specifications

Grandezza BBQ - BBQ size 39,5 x 22 cm

Grandezza griglia - Grid size 28 cm

T° range 0-430 C°

PESI E DIMENSIONI

Weights and dimensions

Ingombro BBQ - BBQ size 52,5 x 22 x 16 cm

Ingombro Box - Box size 55 x 28 x 27,5 cm

Peso lordo - Gross weight 24 Kg

Peso netto - Net weight 22 Kg

CODICE

BABBQRE

PREZZO IVA ESCLUSA

€ 341,25

ACCESSORI GENERALI



Carbone 100% Quebracho Blanco
pezzatura grande >80mm

100% Quebracho Blanco charcoal
Large size >80mm

CODICE	BA15CARB
DESCRIZIONE	Sacco 15 kg
PREZZO IVA ESCLUSA	€ 71,40



Carbone 100% Quebracho Blanco
pezzatura media 40-80 mm

100% Quebracho Blanco charcoal
Average size 40-80 mm

CODICE	BA10CARB
DESCRIZIONE	Sacco 10 kg
PREZZO IVA ESCLUSA	€ 45,20



Accendi carbone elettrico ad alta
temperatura

High temperature electric
charcoal lighter

CODICE	BACL
POTENZA:	2000W
VOLTAGGIO:	230V
FREQUENZA:	50HZ
T° MAX:	650°C
PREZZO IVA ESCLUSA	€ 76,13

GENERAL ACCESSORIES



Chips di ciliegio per affumicatura

Cherry chips for smoking



Ideale per affumicare maiale - manzo - pollo - agnello

Ideal for smoking pork - beef - chicken - lamb

CODICE BAC-CHERRY

DESCRIZIONE Chips di ciliegio per affumicatura - 3,14 lt

PREZZO IVA ESCLUSA € 21,60



Chips di melo per affumicatura

Apple chips for smoking



Ideale per affumicare maiale - pollo - pesce - verdure

Ideal for smoking pork - chicken - fish - vegetables

CODICE BAC-APPLE

DESCRIZIONE Chips di melo per affumicatura - 3,14 lt

PREZZO IVA ESCLUSA € 21,60



Chips di nocciolo americano per affumicatura

American hazelnut chips for smoking



Ideale per affumicare maiale - pollo - pesce - formaggi

Ideal for smoking pork - chicken - fish - cheese

CODICE BAC-PECAN

DESCRIZIONE Chips di nocciolo americano per affumicatura - 3,14 lt

PREZZO IVA ESCLUSA € 21,60



Chips di noce americana per affumicatura

Hickory chips for smoking



Ideale per affumicare maiale - manzo - pollo - pesce

Ideal for smoking pork - beef - chicken - fish

CODICE BAC-HICKORY

DESCRIZIONE Chips di noce americana per affumicatura - 3,14 lt

PREZZO IVA ESCLUSA € 21,60

ELEGANCE- LAMA LISCIA - SMOOTH BLADE



- **MANICO IN POM:** POLIOSSIMETILENE HA ELEVATE PROPRIETÀ PER QUANTO RIGUARDA LE CARATTERISTICHE DI DUREZZA, RIGIDITÀ, RESISTENZA CHIMICA, ATTRITO E ABRASIONE, PUÒ SOSTITUIRE I METALLI IN MOLTE APPLICAZIONI. IL POM RESISTE A TEMPERATURE FINO A 130°.
- **LAMA TRAPEZOIDALE** ACCIAIO INOSSIDABILE MARTENSITICO UNI: XR30Cr13
- **3 RIVETTI** È UN COLTELLO OTTENUTO MEDIANTE FORGIATURA CON 8 FASI DI LAVORAZIONE
- **POM HANDLE:** POLYOXYMETHYLENE HAS EXCELLENT PROPERTIES IN TERMS OF HARDNESS, RIGIDITY, CHEMICAL RESISTANCE, FRICTION, AND ABRASION. IT CAN REPLACE METALS IN MANY APPLICATIONS. POM WITHSTANDS TEMPERATURES UP TO 130°C.
- **TRAPEZOIDAL BLADE:** MARTENSITIC STAINLESS STEEL UNI X30Cr13.
- **3 RIVETS:** THIS KNIFE IS PRODUCED THROUGH A FORGING PROCESS CONSISTING OF 8 MANUFACTURING STAGES.



CODICE / CODE	DESCRIZIONE / DESCRIPTION	UDV	IVA ESC.
84BL	6 per blister, 60 coltelli per cartone 6 per blister, 60 knives per carton	60	€ 8,40

ELEGANCE LAMA SEGHETTATA SERRATED BLADE



- **MANICO IN POM:** POLIOSSIMETILENE HA ELEVATE PROPRIETÀ PER QUANTO RIGUARDA LE CARATTERISTICHE DI DUREZZA, RIGIDITÀ, RESISTENZA CHIMICA, ATTRITO E ABRASIONE, PUÒ SOSTITUIRE I METALLI IN MOLTE APPLICAZIONI. IL POM RESISTE A TEMPERATURE FINO A 130°.
- **LAMA TRAPEZOIDALE** ACCIAIO INOSSIDABILE MARTENSITICO UNI: XR30Cr13
- **3 RIVETTI** È UN COLTELLO OTTENUTO MEDIANTE FORGIATURA CON 8 FASI DI LAVORAZIONE
- **POM HANDLE:** POLYOXYMETHYLENE HAS EXCELLENT PROPERTIES IN TERMS OF HARDNESS, RIGIDITY, CHEMICAL RESISTANCE, FRICTION, AND ABRASION. IT CAN REPLACE METALS IN MANY APPLICATIONS. POM WITHSTANDS TEMPERATURES UP TO 130°C.
- **TRAPEZOIDAL BLADE:** MARTENSITIC STAINLESS STEEL UNI X30Cr13.
- **3 RIVETS:** THIS KNIFE IS PRODUCED THROUGH A FORGING PROCESS CONSISTING OF 8 MANUFACTURING STAGES.



CODICE / CODE	DESCRIZIONE / DESCRIPTION	UDV	IVA ESC.
84BS	6 per blister, 60 coltelli per cartone 6 per blister, 60 knives per carton	60	€ 8,40

BASIC

- **MANICO IN POM:** POLIOSSIMETILENE HA ELEVATE PROPRIETÀ PER QUANTO RIGUARDA LE CARATTERISTICHE DI DUREZZA, RIGIDITÀ, RESISTENZA CHIMICA, ATTRITO E ABRASIONE, PUÒ SOSTITUIRE I METALLI IN MOLTE APPLICAZIONI. IL POM RESISTE A TEMPERATURE FINO A 130°.
- **LAMA TRAPEZOIDALE** ACCIAIO INOSSIDABILE MARTENSITICO UNI: XR30CR13
- **3 RIVETTI** È UN COLTELLO OTTENUTO MEDIANTE FORGIATURA CON 8 FASI DI LAVORAZIONE
- **POM HANDLE** POLYOXYMETHYLENE HAS EXCELLENT PROPERTIES IN TERMS OF HARDNESS, RIGIDITY, CHEMICAL RESISTANCE, FRICTION, AND ABRASION. IT CAN REPLACE METALS IN MANY APPLICATIONS. POM WITHSTANDS TEMPERATURES UP TO 130°C.
- **TRAPEZOIDAL BLADE:** MARTENSITIC STAINLESS STEEL UNI X30CR13.
- **3 RIVETS:** THIS KNIFE IS PRODUCED THROUGH A FORGING PROCESS CONSISTING OF 8 MANUFACTURING STAGES.



CODICE / CODE	DESCRIZIONE / DESCRIPTION	UDV	IVA ESC.
40BS	12 per scatola, 120 coltelli per cartone 12 per box, 120 knives per carton	120	€ 2,08

BASIC LAMA CORTA - SHORT BLADE

- **MANICO IN POM:** POLIOSSIMETILENE HA ELEVATE PROPRIETÀ PER QUANTO RIGUARDA LE CARATTERISTICHE DI DUREZZA, RIGIDITÀ, RESISTENZA CHIMICA, ATTRITO E ABRASIONE, PUÒ SOSTITUIRE I METALLI IN MOLTE APPLICAZIONI. IL POM RESISTE A TEMPERATURE FINO A 130°.
- **LAMA TRAPEZOIDALE** ACCIAIO INOSSIDABILE MARTENSITICO UNI: XR30CR13
- **3 RIVETTI** È UN COLTELLO OTTENUTO MEDIANTE FORGIATURA CON 8 FASI DI LAVORAZIONE
- **POM HANDLE** POLYOXYMETHYLENE HAS EXCELLENT PROPERTIES IN TERMS OF HARDNESS, RIGIDITY, CHEMICAL RESISTANCE, FRICTION, AND ABRASION. IT CAN REPLACE METALS IN MANY APPLICATIONS. POM WITHSTANDS TEMPERATURES UP TO 130°C.
- **TRAPEZOIDAL BLADE:** MARTENSITIC STAINLESS STEEL UNI X30CR13.
- **3 RIVETS:** THIS KNIFE IS PRODUCED THROUGH A FORGING PROCESS CONSISTING OF 8 MANUFACTURING STAGES.



CODICE / CODE	DESCRIZIONE / DESCRIPTION	UDV	IVA ESC.
40P	12 per scatola, 120 coltelli per cartone 12 per box, 120 knives per carton	120	€ 2,60



No induzione

No induction



**PENTOLA CON DUE MANIGLIE
ALLUMINIO FUSO**

STOCKPOT, 2 HANDLES

Code	Ø cm	H cm	lt	IVA esc.
FAMA314	14	12	2	13,92 €
FAMA316	16	14	2,7	16,02 €
FAMA318	18	16	4	19,06 €
FAMA320	20	18	5,5	24,08 €
FAMA322	22	20	7,5	26,91 €
FAMA324	24	22	10	32,95 €
FAMA326	26	24	12,5	40,27 €
FAMA328	28	26	15	45,41 €
FAMA330	30	28	20	49,95 €
FAMA332	32	30	24	54,89 €
FAMA334	34	32	29	61,79 €
FAMA336	36	33	35	71,98 €
FAMA338	38	35	40	78,57 €
FAMA340	40	37	48	86,15 €

**CASSERUOLA ALTA CON DUE
MANIGLIE ALLUMINIO FUSO**

SAUCEPOT, 2 HANDLES



Code	Ø cm	H cm	lt	IVA esc.
FAMA412	12	6	1	10,24 €
FAMA414	14	7	1,5	12,76 €
FAMA416	16	8	1,9	14,63 €
FAMA418	18	9	2,5	15,85 €
FAMA420	20	10	3,3	18,72 €
FAMA422	22	11	4,5	20,13 €
FAMA424	24	12	5,5	23,32 €
FAMA426	26	13	7	28,20 €
FAMA428	28	14	8,5	32,13 €
FAMA430	30	15	10	37,38 €
FAMA432	32	16	12	41,58 €
FAMA434	34	17	15	46,50 €
FAMA436	36	18	18	51,24 €
FAMA438	38	19	21	55,87 €
FAMA440	40	20	25	60,23 €

**CASSERUOLA BASSA CON DUE MANIGLIE
ALLUMINIO FUSO**

CASSEROLE POT, 2 HANDLES



Code	Ø cm	H cm	lt	IVA esc.
FAMA614	14	5	1	10,63 €
FAMA616	16	5,5	1,3	12,60 €
FAMA618	18	6,5	1,8	14,65 €
FAMA620	20	7,5	2,5	17,26 €
FAMA622	22	8,5	3,3	18,00 €
FAMA624	24	9	4	19,77 €
FAMA626	26	9,5	5	27,07 €
FAMA628	28	10	6	30,45 €
FAMA630	30	11	7,5	36,87 €
FAMA632	32	11,5	8,5	40,68 €
FAMA634	34	12	10	45,08 €
FAMA636	36	13	13	48,27 €
FAMA638	38	13,5	15	53,72 €
FAMA640	40	14	17	58,77 €

**CASSERUOLA OVALE CON DUE MANIGLIE
IN ALLUMINIO E COPERCHIO**

OVAL SAUCEPOT, OPAQUE FINISH, 2 ALU
HANDLES AND LID



Code	Ø cm	H cm	lt	IVA esc.
FAMA2628	28	13	8	61,58 €
FAMA2630	30	13	9,19	66,74 €
FAMA2632	32	14	11,26	68,89 €
FAMA2634	34	14	12,7	72,24 €
FAMA2636	36	14	14,25	84,86 €

**CASSERUOLA ALTA CON UN MANICO
ALLUMINIO FUSO**

SAUCEPAN, 1 HANDLE



Code	Ø cm	H cm	lt	IVA esc.
FAMA512	12	6	1	9,53 €
FAMA514	14	7	1,5	10,80 €
FAMA516	16	8	1,9	13,09 €
FAMA518	18	9	2,5	14,02 €
FAMA520	20	10	3,3	16,60 €
FAMA522	22	11	4,5	19,62 €
FAMA524	24	12	5,5	22,58 €
FAMA526	26	13	7	25,28 €



TEGAME CON DUE MANIGLIE
ALLUMINIO FUSO

OMELETTE PAN, 2 HANDLES

Code	Ø cm	H cm	IVA esc.
FAMA1012	12	3	9,26 €
FAMA1014	14	3	10,63 €
FAMA1016	16	3,5	10,97 €
FAMA1018	18	3,5	11,30 €
FAMA1020	20	4	12,60 €
FAMA1022	22	5	14,35 €
FAMA1024	24	5	15,93 €
FAMA1026	26	5,5	17,07 €
FAMA1028	28	6	19,11 €
FAMA1030	30	6	21,73 €
FAMA1032	32	6	23,23 €
FAMA1034	34	6,5	25,51 €
FAMA1036	36	6,5	27,65 €
FAMA1038	38	7	30,04 €
FAMA1040	40	7	33,74 €



PADELLA CON UN MANICO
ALLUMINIO FUSO

FRYPAN, 1 HANDLE

Code	Ø cm	H cm	IVA esc.
FAMA1112	12	3	8,51 €
FAMA1114	14	3	8,94 €
FAMA1116	16	3,5	9,97 €
FAMA1118	18	3,5	10,31 €
FAMA1120	20	4	11,95 €
FAMA1122	22	5	13,51 €
FAMA1124	24	5	14,52 €
FAMA1126	26	5,5	15,11 €
FAMA1128	28	6	15,69 €
FAMA1130	30	6	17,57 €
FAMA1132	32	6	22,80 €
FAMA1134	34	6,5	24,99 €
FAMA1136	36	6,5	26,45 €
FAMA1138	38	7	30,62 €
FAMA1140	40	7	31,91 €

**CASSERUOLA CONICA CON UN MANICO
ALLUMINIO FUSO E BECCO**



CONICAL CASSESOLE PAN WITH SPOUT
AND HANDLE

Code	Ø cm	H cm	lt	IVA esc.
FAMA910	10	7	0,5	8,09 €
FAMA912	12	8	0,9	8,64 €
FAMA914	14	8,5	1,2	10,52 €
FAMA916	16	10	1,3	12,16 €
FAMA918	18	11,5	1,9	14,02 €
FAMA920	20	12,5	2,4	17,21 €
FAMA922	22	14	3	19,46 €
FAMA924	24	15,5	4,3	22,15 €
FAMA926	26	16	6	25,09 €

**COPERCHIO OVALE
CON PONTICELLO ALLUMINIO**



OVAL LID

Code	Ø cm	IVA esc.
FAMA29OV28	28	17,74 €
FAMA29OV30	30	19,61 €
FAMA29OV32	32	23,44 €
FAMA29OV34	34	28,30 €
FAMA29OV36	36	30,79 €

**COPERCHIO LUCIDO PIANO TIPO PESANTE
CON ORLO E PONTICELLO CONF. 10 PZ.**

HEAVY FLAT LID WITH LOOP HANDLE -
PACK 10 PCS



Code	Ø cm	IVA esc.
FAMA2910	10	4,77 €
FAMA2912	12	5,10 €
FAMA2914	14	5,34 €
FAMA2916	16	6,36 €
FAMA2918	18	6,77 €
FAMA2920	20	7,75 €
FAMA2922	22	8,54 €
FAMA2924	24	9,56 €
FAMA2926	26	10,07 €
FAMA2928	28	10,85 €
FAMA2930	30	11,90 €
FAMA2932	32	13,10 €
FAMA2934	34	15,44 €
FAMA2936	36	18,43 €
FAMA2938	38	19,87 €
FAMA2940	40	21,52 €



**COLAPASTA 3 PIEDI CON DUE MANIGLIE
ALLUMINIO FUSO**

TRIPODAL PASTA COLANDER, 2 HANDLES

Code	cm	H cm	IVA esc.
FAMA1520	20	13	21,52 €
FAMA1522	22	14	23,00 €
FAMA1524	24	15	25,49 €
FAMA1526	26	15	30,41 €
FAMA1528	28	16,5	32,70 €
FAMA1530	30	16,5	34,65 €



**COLAPASTA CON UN MANICO E GANCIO
ALLUMINIO FUSO**

PASTA COLANDER, 1 HANDLE AND HOOK

Code	cm	H cm	IVA esc.
FAMA4020	20	13	15,43 €
FAMA4022	22	14	17,92 €
FAMA4024	24	15	21,37 €



**COLARISO CON UN MANICO E GANCIO
ALLUMINIO FUSO**

RICE COLANDER, OPAQUE FINISH, 1
HANDLE AND HOOK. LITTLE HOLES

Code	cm	H cm	IVA esc.
FAMA3214	14	6,5	10,20 €
FAMA3216	16	7,5	11,83 €
FAMA3218	18	8,5	12,65 €



**PESCIERA TIPO ECONOMICO CON ORLO,
DUE MANIGLIE IN ALLUMINIO, COPERCHIO
E GRIGLIA**

FISH-KETTLE, OPAQUE FINISH, ECONOMIC
MODEL. WITH ALUMINIUM HANDLE RIM. LID

Code	cm	H cm	IVA esc.
FAMA1835	35x14,5	9,5	74,42 €
FAMA1840	40x14,5	10,7	76,04 €
FAMA1845	45x15,2	10,7	78,54 €
FAMA1850	50x16	11	96,90 €



**COPERCHIO PER ROSTIERA
RETTANGOLARE - ART. 50**

LID FOR RECTANGULAR ROASTING PLATE
ART. 50

Code	Ø cm	IVA esc.
FAMA83B26	26x20	10,20 €
FAMA83B32	32x23	11,83 €
FAMA83B35	35x26	12,31 €
FAMA83B40	40x29	12,81 €
FAMA83B45	45x30	31,55 €



**ROSTIERA RETTANGOLARE ANGOLI TONDI
SENZA COPERCHIO**

RECTANGULAR ROASTING PLATE, OPAQUE
FINISH ROUND ANGLES WITHOUT LID

Code	est. cm	int. cm	H cm	IVA esc.
FAMA5026	26,5x20	26x20	6	13,51 €
FAMA5032	32x23,8	32x23	6	15,43 €
FAMA5035	36,3x26	35x26	6,5	18,25 €
FAMA5040	41,5x29,7	40x29	7	23,15 €
FAMA5045	47,5x31,8	45x30	7,5	41,63 €



SECCHIO LATTE

MILK BUCKET, OPAQUE FINISH

Code	Ø cm	H cm	lt	IVA esc.
FAMA8008	25,3	22,5	8	43,03 €
FAMA8010	25,5	26,7	10	45,99 €
FAMA8012	29,5	30	12	51,92 €
FAMA8015	30,5	31	15	61,60 €
FAMA8020	32	33	20	89,19 €



PAIOLO CON MANICO ARCO E ORLO

POLENTA POT, BOWED HANDLE WITH RIM

Code	Ø cm	H cm	lt	IVA esc.
FAMA4420	20	12,5	3	17,78 €
FAMA4422	22	15,5	3,5	20,16 €
FAMA4424	24	17	4,5	20,68 €
FAMA4426	26	18	6	26,24 €
FAMA4428	28	18	7	28,94 €
FAMA4430	30	21	8	33,49 €
FAMA4432	32	23	10	42,40 €
FAMA4434	34	24	15	57,91 €
FAMA4436	36	25	16	69,64 €
FAMA4438	38	26,5	17	79,62 €
FAMA4440	40	28	20	84,27 €

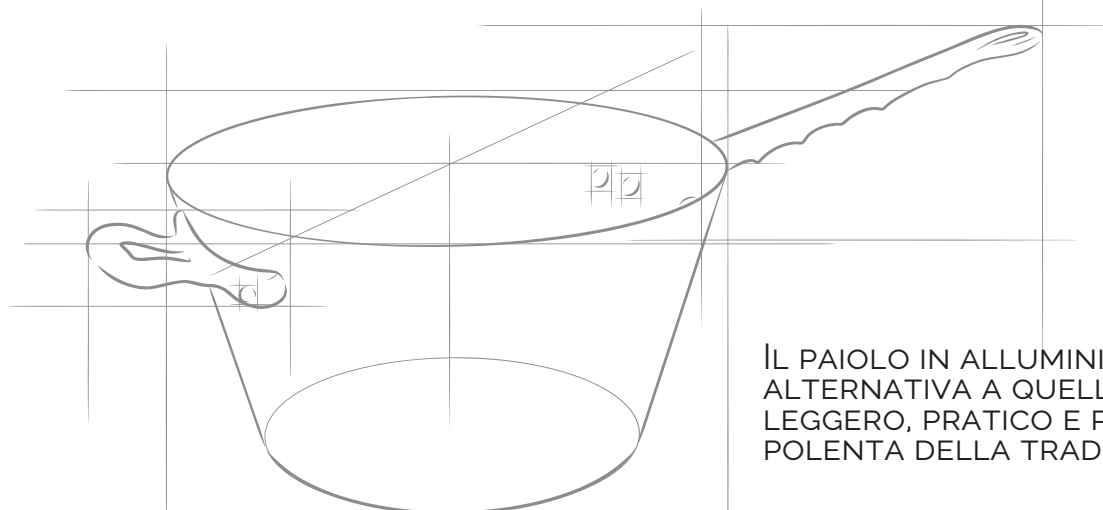

IL PAIOLO IN ALLUMINIO È UN'OTTIMA ALTERNATIVA A QUELLO IN RAME, LEGGERO, PRATICO E PERFETTO PER LA POLENTA DELLA TRADIZIONE.

THE ALUMINUM POT IS AN EXCELLENT ALTERNATIVE TO COPPER: LIGHT, PRACTICAL, AND PERFECT FOR TRADITIONAL POLENTA.



PAIOLO CON UN MANICO E MANIGLIA INOX

POLENTA POT. 1 HANDLE AND HAND GRIP

Code	Ø cm	H cm	lt	IVA esc.
FAMA6518	18	12	2	13,04 €
FAMA6520	20	13	3	15,27 €
FAMA6522	22	14	3,5	16,93 €
FAMA6524	24	14	4,5	18,97 €
FAMA6526	26	17	6	22,53 €
FAMA6528	28	17	7	24,20 €
FAMA6530	30	18	8	26,05 €



**FORNETTO CON OCCHIO CON
SPARGIFIAMMA ALLUMINIO FUSO E
TORTIERE 10/10**

BAKE-STOVE WITH EYE

Code	Ø cm	Ø tortiera cm	H cm	IVA esc.
COALFORNOOCCHIO30	33.5	27	23.5	95.52 €
COALFORNOOCCHIO35	38.5	30.5	28	108.39 €

IL FORNETTO CON OCCHIO È L'ALTERNATIVA PRATICA AL FORNO: CUOCE SU FORNELLO E TI PERMETTE DI CONTROLLARE LA COTTURA SENZA MAI SOLLEVARE IL COPERCHIO.

THE STOVETOP OVEN WITH VIEWING EYE IS A SMART ALTERNATIVE TO A TRADITIONAL OVEN: IT COOKS ON THE HOB AND LETS YOU CHECK DONENESS WITHOUT LIFTING THE LID.

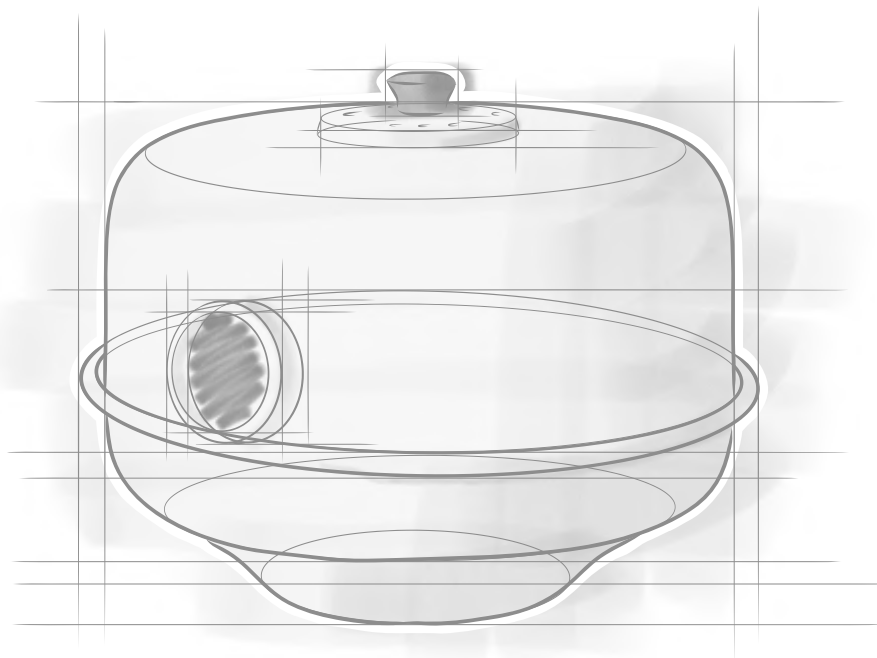

**FORNETTO PER DOLCI COMPLETO DI
COPERCHIO E PIASTRA IN FERRO**

BAKE-STOVE WITH LID AND IRON GRID

Code	Ø cm	H cm	IVA esc.
FAMR8626	26	14,5	32.15 €
FAMR8628	28	16	35.00 €
COFE86	fondello singolo		2.16 €

Condizioni generali di vendita Italia

INFO:

- I nostri Agenti ed i nostri addetti commerciali sono a Vs. completa disposizione per qualsiasi informazione vi possa servire - Riferimenti e numeri sono riportati di seguito.

ORDINI e RIFERIMENTI UFFICI

- Richieste e ordini possono essere inviati o trasmessi ai seguenti indirizzi:
- Contattando i nostri agenti di vendita al telefono o tramite mail.

• Ufficio Commerciale Italia Centralino

Tel. +39.035.204711
info@agnelli.it

• Customer service

Tel. +39.035.204725
customerservice@agnelli.net

• Ufficio Commerciale Export

Tel. +39.035.204752
export@agnelli.net

• Amministrazione

Tel. +39.035.204732
Fax +39.035.204742
amministrazione@agnelli.net

- Tutti gli ordini sono soggetti ad approvazione della Baldassare Agnelli S.p.A.
- Ordini minimi di € 250,00 netto merce.
- Tempi di consegna, entro 10 gg lavorativi dalla data di conferma d'ordine.
- Addebito in fattura di € 2,50 per ogni ricevuta bancaria emessa.

CONDIZIONI DI CONSEGNA / TRASPORTI IN ITALIA

- Gli ordini saranno consegnati in "PORTO FRANCO" al

domicilio del Cliente a mezzo corriere convenzionato con la Baldassare Agnelli SpA con le seguenti modalità:

a) Per Regioni del nord Italia, PORTO FRANCO per ordini superiori ad € 500,00 netto merce - Per ordini d'importo inferiore, da € 250,00 a € 500,00 addebito fisso di € 19,00 netto in fattura.

b) Per Regioni del Centro Italia, PORTO FRANCO per ordini superiori ad € 800,00 netto merce - Per ordini d'importo inferiore, da € 250,00 a € 800,00 addebito del 4% con un minimo fisso di € 25,00 netto in fattura.

c) Per Regioni del Sud Italia e isole, PORTO FRANCO per ordini superiori ad € 1.200,00 netto merce - Per ordini d'importo inferiore, da € 250,00 a € 1.200,00 addebito del 6% con un minimo fisso di € 35,00 netto in fattura.

d) Gli ordini ritirati da corrieri convenzionati con il Cliente, saranno resi disponibili nei tempi sopra descritti, in "franco fabbrica" presso il nostro stabilimento di Lallio (BG).

*Nord Italia: Valle d'Aosta, Piemonte, Liguria, Lombardia, Veneto, Trentino Alto Adige, Friuli Venezia Giulia, Emilia Romagna.

**Centro Italia: Toscana, Umbria, Marche, Abruzzo, Molise e Lazio.

***Sud Italia e isole: Campania, Basilicata, Puglia, Calabria, Sicilia e Sardegna.

- Addebito aggiuntivo per consegna con "sponda idraulica": € 25 a consegna
- Addebito aggiuntivo per consegna "urgente/tassativa": € 30,00 a consegna
- Addebito aggiuntivo per invio "contrassegno": 2%

dell'importo imponibile della fattura.

- Addebito aggiuntivo per ordini inferiori 250€ : € 10,00
- Nel caso la spedizione subisse una giacenza presso i magazzini del corriere per cause a noi non imputabili, saranno addebitati al cliente i relativi costi sostenuti da Baldassare Agnelli SpA.

RESI / RECLAMI

- Eventuali contestazioni per colli o bancali ricevuti danneggiati esternamente, dovranno essere segnalate direttamente sul documento consegnato dal corriere convenzionato con la Baldassare Agnelli SpA ed inviate in copia ai nostri uffici commerciali. Tali contestazioni dovranno essere abbinata a documentazione fotografica che attesti il danno subito.

- La merce ricevuta, dovrà essere controllata allo scarico e entro pochi giorni dalla consegna, non si accettano segnalazioni successive ai sette giorni lavorativi dalla data di ricezione della merce.

- Qualsiasi richiesta di reso delle merci dovrà pervenire tramite i nostri Agenti o direttamente ai nostri uffici commerciali con il relativo modulo di "richiesta di autorizzazione al reso" disponibile presso i nostri uffici commerciali o tramite gli agenti, tale richiesta di reso verrà autorizzata e ne seguirà un modulo di qualità e dal relativo controllo qualità dell'ufficio commerciale.

- In caso di responsabilità da parte di Baldassare Agnelli SpA, provvederemo a ritirare a nostre spese e sostituire la merce segnalata

danneggiando in porto franco al domicilio del Cliente.

- In caso di reso a carico del Cliente, la merce dovrà essere resa "franco fabbrica" e la Baldassare Agnelli SpA addebiterà una percentuale del 15% sul valore netto con un minimo di € 20,00 per spese di gestione, per accreditare gli articoli resi, gli stessi saranno accreditati a valore di "rottame a peso" comunicando l'importo al momento del rettifico.

- Non sarà possibile rendere eventuali articoli ordinati su "richiesta" o "personalizzati" o "fuori produzione" e non inoltre prevista e autorizzata nessuna forma di "reso dell'invenduto".

PERSONALIZZAZIONI

- Esiste la possibilità di personalizzare i prodotti a condizioni di ordine con i nostri uffici commerciali, di seguito alcune indicazioni:

- Le personalizzazioni possono essere praticate tramite "incisione laser" e tramite "punzone" in funzione delle quantità dell'ordine e della tipologia di richiesta.

- Il nostro ufficio grafico richiederà i file nei formati necessari per apporre il logo.

- Qualsiasi richiesta dovrà essere valutata dall'ufficio commerciale e dall'ufficio tecnico produttivo e sarà seguita da un preventivo di spesa con i tempi di realizzazione.

- Qualsiasi ordinativo di merce personalizzata dovrà essere seguito da un versamento di un acconto del 30% dell'importo totale dell'ordine e dal saldo prima della spedizione della merce.

- Non potranno essere accettati resi di merce personalizzata.

Condizioni di consegna e trasporto all'estero

- Tutte le consegne per Stati Esteri sono effettuate a condizione: Ex Works - Franco Fabbrica.
- Condizioni diverse dovranno essere accordate con il nostro ufficio commerciale.

Export Dept
Tel. +39.035.204752
export@agnelli.net

Delivery terms / international transport

- All deliveries to foreign countries follow an Ex-Works condition
- Different conditions should be agreed with our Sales Office

Conditions de livraison / transports internationaux

- Toutes les livraisons pour les États étrangers sont effectuées sous conditions Ex-Works - franco notre usine.
- Conditions différentes doivent être concordées avec notre Bureau Commerciale.

Lieferbedingungen / Auslandstransporte

- Alle Auslandsieferungen werden unter den Bedingungen ab Werk - Frei Werk ausgeführt.
- Andere Bedingungen können mit unserem Handelsbüro vereinbart werden.

CERTIFICAZIONI

I prodotti Pentole Agnelli rappresentano il Made in Italy in tutto il mondo, segno di qualità e tradizione.

Pentole Agnelli aderisce al programma €peo AFFF (Aluminium For Future Generation) ed a CentroAl - Alluminio in Cucina, il consorzio che riunisce in Italia i Produttori di Pentole Professionali.

Pentole Agnelli persegue l'obiettivo della piena soddisfazione dei propri clienti attraverso un prodotto di qualità, un servizio garantito da personale specializzato, il rispetto della puntualità nelle consegne ed un prezzo competitivo.

Pentole Agnelli ha attuato un Sistema di Gestione per la Qualità in accordo ai requisiti della norma UNI EN ISO 9001:2008 per la quale è stata certificata.

Essendo ancora la nostra una produzione artigianale le misure non possono essere considerate precise al millimetro ma soltanto indicative.

"Adozione del Modello organizzativo 231": Baldassare Agnelli Spa, aderendo alla propria filosofia aziendale ed al fine di prevenire la commissione di reati, ha adottato con delibera del Consiglio di Amministrazione del 12/04/2019 il modello previsto dal d.l. Lgs 231/2001, nonché il Code Etico, come parte integrante del predetto modello.



Registrazione N° IT-21012 IGQ 2640
Azienda con Sistema Qualità Certificato

Agnelli
SINCE 1907

HORECA PROFESSIONAL